

F007K/KD SERIES FEATURES

全新人體工學，圓弧流線時尚的外型設計，使用方便順手，賞心悅目
Brand new design of fashionable and smooth appearance, easy to sew.



上夾線裝置

出刀迅速精準，夾線穩定。

Upper Thread Gripper

Newly designed auto trimmer trims precisely and stably.



內縮式床台

縫製物更靠近機針，車縫定位精準，車縫時更加順暢就手。

The Recessed Machine Bed

The sewing material is closer to the needle and the sewing is precise, which makes sewing operation easier and smoother.



拷克骨車縫附調整式進布誘導器，活動式壓腳，車縫適用性更廣

Cover seaming with adjustable folder, flexible presser foot, accommodate wider range of sewing items.



自動切線系列新設計氣/電動上下切刀組

出刀迅速穩定精準，切線俐落，輕順低噪音調整容易。

Auto trimmer with newly designed pneumatic / electric trimming system

trims precisely and stably, lower sound and easy to adjust.



規格 SPECIFICATIONS F007KD - W121 - 2 40 /FHA/DFKU

規格索引，詳細請參考P.71 Specification index, please refer to P.71

- ① 機種別 Model
- ② 系列 Series
- ③ 網線方式 Covering Types
- ④ 功能 Function
- ⑤ 針板舌片 Needle Plate Finger
- ⑥ 針數 Needle Numbers
- ⑦ 針距 Needle gauge
- ⑧ 配件 Device
- ⑨ 馬達 Motor
U : U Series
H : H Series

F1

	⑥		⑦				⑨	
F007KD-W121-⑥⑦/FHA/⑨	2	4	4.0/4.8	1.6 ~ 4.2	0.5 ~ 1.3	5	H / U	6000
	3	5	5.6/6.4	1.6 ~ 4.2	0.5 ~ 1.3	5	H / U	6000
F007KD-W122-⑥⑦/FHA/⑨	2	4	4.0/4.8	1.6 ~ 4.2	0.5 ~ 1.3	5	H / U	6000
	3	5	5.6/6.4	1.6 ~ 4.2	0.5 ~ 1.3	5	H / U	6000
F007KD-W123-⑥⑦/FHA/⑨	2	4	4.0/4.8	1.6 ~ 4.2	0.5 ~ 1.3	5/7	H / U	6000
	3	5	5.6/6.4	1.6 ~ 4.2	0.5 ~ 1.3	5/7	H / U	6000
F007KD-W162-⑥⑦/FHA/⑨	3	5	5.6/6.4	1.6 ~ 4.2	0.5 ~ 1.3	5/7	H / U	6000
F007KD-W162H-⑥⑦/FHA/⑨	3	5	5.6/6.4	6	0.5 ~ 1.3	5/7	H / U	6000

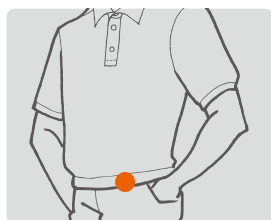

一般平縫 / 下擺車縫

本機型為雙面飾繃縫筒車之基本機型，可裝配附件進行多種功能車縫
例如：內衣褲、運動衫接縫及下擺車縫(附可調式下擺車縫組)。

GENERAL SEAMING / BOTTOM HEMMING

Basic model of interlock sewing machine with double side cover-stitching. It is available for various sewing by optional devices. Such as plain seaming and bottom hemming for underwears, sportswears, etc... (equipped with adjustable hemming set)

- W121 : 薄布料 Light material
- W122 : 中厚布料 Medium material
- W123 : 厚布料 Heavy material
- W162 : 高行程 High needle bar stroke
- W162H : 高行程 High needle bar stroke
大針距(6mm) Long stitch length (6mm)

選購配件 OPTIONAL DEVICE
UTG , UTH , UTJ , UTK , FL

規格

SPECIFICATIONS

F007KD - W222 - 2 40 /FQ/DFKU

規格索引，詳細請參考P.71 Specification index, please refer to P.71

- ① 機種別 Model
- ② 系列 Series
- ③ 網線方式 Covering Types
- ④ 功能 Function
- ⑤ 針板舌片 Needle Plate Finger
- ⑥ 針數 Needle Numbers
- ⑦ 針距 Needle gauge
- ⑧ 配件 Device
- ⑨ 馬達 Motor
U : U Series
H : H Series

F2



F007KD-W222-⑥⑦/FQ/⑨	2	4	4.0/4.8	1.6 ~ 4.2	0.5 ~ 1.3	5	H / U	6000
	3	5	5.6/6.4	1.6 ~ 4.2	0.5 ~ 1.3	5	H / U	6000
F007KD-W222-⑥⑦/FFD/⑨	2	4	4.0/4.8	1.6 ~ 4.2	0.5 ~ 1.3	5	H / U	6000
	3	5	5.6/6.4	1.6 ~ 4.2	0.5 ~ 1.3	5	H / U	6000
F007KD-W222-⑥⑦/FFP/⑨	2	4	4.0/4.8	1.6 ~ 4.2	0.5 ~ 1.3	5	H / U	6000
	3	5	5.6/6.4	1.6 ~ 4.2	0.5 ~ 1.3	5	H / U	6000



F007KD-W222-356/FQ/FEC



F007KD-W222-356/FFD



F007KD-W222-356/FFP

FQ:上帶滾邊車縫

適用於 T 恤、內衣褲之領口、褲管口等上帶滾邊之車縫工程，可加附電動(FEC)或氣動式(FAC)長切刀式切布條裝置，能將滾邊布條切斷，節省布條之用料增加車縫效率。

FQ:TAPE BINDING

For tape binding on openings of leg or neck of underwears, T-shirts, etc... Also can attach electric(FEC) or pneumatic(FAC) tape cutter to save tape and increase sewing efficiency.



◀ 以上機型可加裝
FNC, FSC:
電眼型後切刀附直驅馬達

Optional device for the above models
FNC, FSC:
Sensor type rear cutter with direct drive servo motor

FFD / FFP:上帶滾邊車縫包覆鬆緊帶

上送帶裝置控制鬆緊帶張力，加上膝動控制鬆緊帶之左右移動，能有效讓鬆緊帶前後段與衣身車縫固定，適用於內褲之褲頭、褲腳之滾邊加鬆緊帶之車縫工程。

FFD: 齒輪箱型精準張力控制

FFP: 彈簧片型簡易張力控制

FFD / FFP:TAPE BINDING WITH ELASTIC BAND

Top feeding device controls the elastic band's tension. Elastic band right-left position controller (by knee-pushing) sets the materials joining at the beginning and ending of waistband, leg opening of briefs...etc.

FFD: Gearbox type for accurate tension control

FFP: Spring type for simple tension control

選購配件 OPTIONAL DEVICE

FA, LF-A, FAC, FEC, LS-A

規格 SPECIFICATIONS F007K - W222 - 2 40 /FSM

規格索引，詳細請參考P.71 Specification index, please refer to P.71

- ① 機種別 Model
- ② 系列 Series
- ③ 網線方式 Covering Types
- ④ 功能 Function
- ⑤ 針板舌片 Needle Plate Finger
- ⑥ 針數 Needle Numbers
- ⑦ 針距 Needle gauge
- ⑧ 配件 Device

F3

	⑥	⑤	⑦	④	③	②	①
F007K-W222-240-4/FSM	2	8	4.0	1.6 ~ 4.2	0.5 ~ 1.3	5	2500
F007K-W222-248-4/FSM	2	8	4.8	1.6 ~ 4.2	0.5 ~ 1.3	5	2500
F007K-W222-364-4/FSM	3	9	6.4	1.6 ~ 4.2	0.5 ~ 1.3	5	2500



F007K-W222-356/FSM

花飾滾邊車縫

用於T恤衫、襯衫等領口、下擺、袖口等花飾滾邊車縫。附有四組花飾凸輪可變化成數百種車縫花樣。

ORNAMENTAL TAPE BINDING

Suitable for ornamental tape binding of neck band, bottom or cuff of T-shirts, shirts, etc...

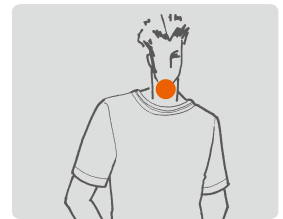

選購配件	OPTIONAL DEVICE
	FA

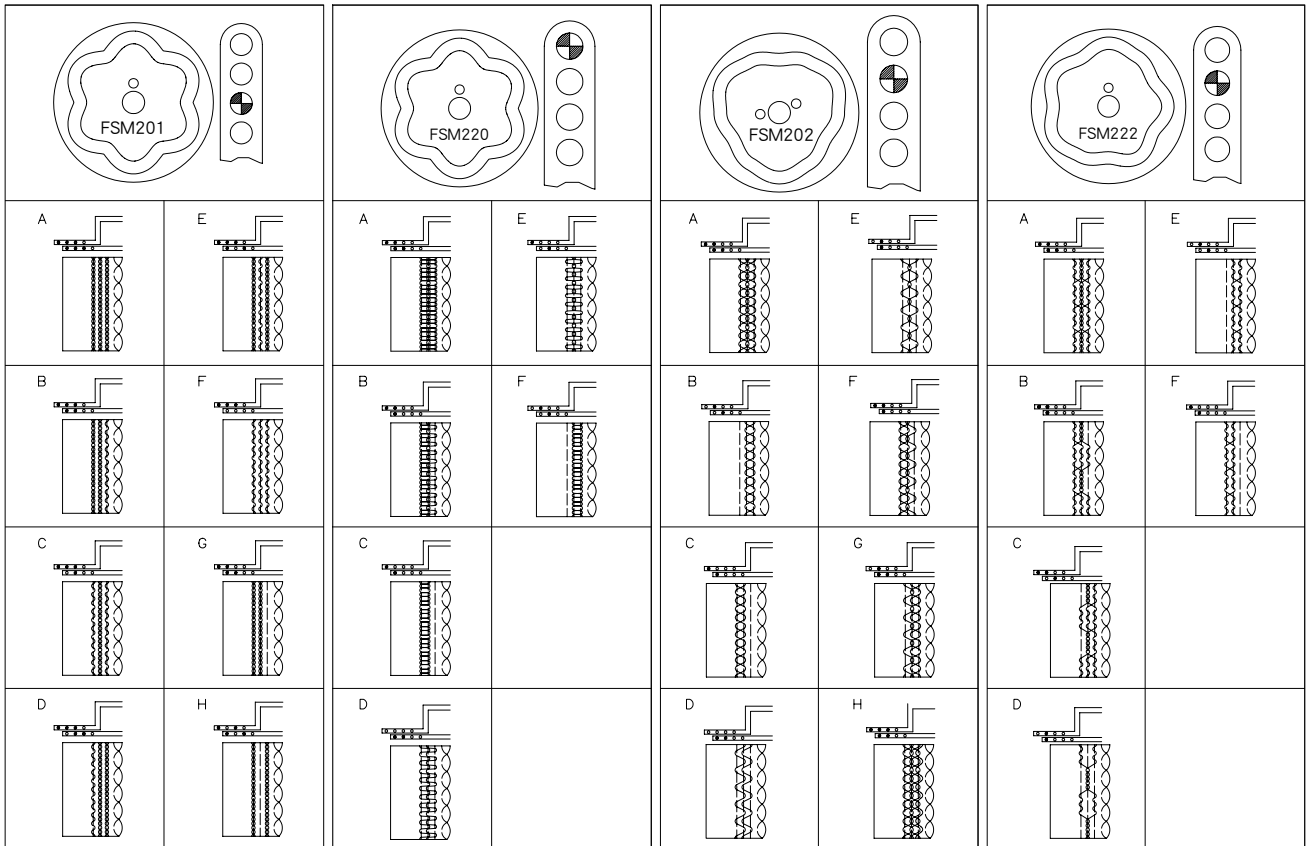

規格

SPECIFICATIONS

F007KD - W322 - 3 56 /FDC/DFKU

規格索引，詳細請參考P.71 Specification index, please refer to P.71

- ① 機種別 Model
- ② 系列 Series
- ③ 網線方式 Covering Types
- ④ 功能 Function
- ⑤ 針板舌片 Needle Plate Finger
- ⑥ 針數 Needle Numbers
- ⑦ 針距 Needle gauge
- ⑧ 配件 Device
- ⑨ 馬達 Motor
U : U Series
H : H Series

F4

	⑥	⑤	⑦	mm	mm	⑨	S.P.M. (Max)	
F007KD-W322-⑥⑦/FDC/⑨	3	5	5.6/ 6.4	1.6 ~ 4.2	0.5 ~ 1.3	5	H / U	6000
F007KD-W322-⑥⑦/FDE/⑨	3	5	5.6/ 6.4	1.6 ~ 4.2	0.5 ~ 1.3	5	H / U	6000



F007KD-W222-356/FDC



F007KD-W322-356/FDE/UTJ/⑨

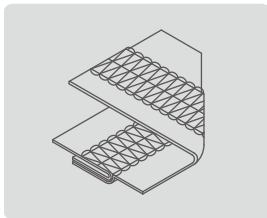

FDC



FDC

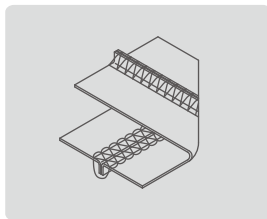

FDE

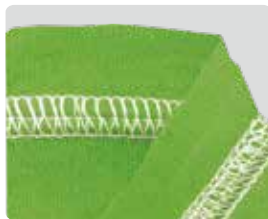

FDE

拷克倒骨蓋縫

FDC 倒骨型：適用於4線包縫之蓋縫。

FDE 立骨型：適用於3線包縫之蓋縫。

配件盒另附有FDC倒骨規格之牛角(導布片)。

OVERLOCK-SEAM COVERING STITCH

FDC Fold-down type : For 4-thread overlock-seam covering stitch.

FDE Flattening type : For 3-thread overlock-seam covering stitch, and an extra guide of overlock-seam (FDC specification, fold-down type) is included in the accessory box.

選購配件 OPTIONAL DEVICE

UTG, UTH, UTJ, UTK

規格 SPECIFICATIONS

F007KD - W52 2 - 2 40/FR /FFC /DFKU

規格索引，詳細請參考P.71 Specification index, please refer to P.71

- ① 機種別 Model
- ② 系列 Series
- ③ 網線方式 Covering Types
- ④ 功能 Function
- ⑤ 針板舌片 Needle Plate Finger
- ⑥ 針數 Needle Numbers
- ⑦ 針距 Needle gauge
- ⑧ 配件 Device
- ⑨ 馬達 Motor
U : U Series
H : H Series

F5

	⑥		⑦				⑨	
F007KD-W522-⑥⑦/FR/FFC/⑨	2	4	4.0/4.8	1.6 ~ 4.2	0.5 ~ 1.3	5	H / U	4500
	3	5	5.6/6.4	1.6 ~ 4.2	0.5 ~ 1.3	5	H / U	4500
F007K-W522-⑥⑦/FR/FE	2	4	4.0/4.8	1.6 ~ 4.2	0.5 ~ 1.3	5	-	4500
	3	5	5.6/6.4	1.6 ~ 4.2	0.5 ~ 1.3	5	-	4500
F007KD-W522-⑥⑦/FR/SMK/⑨	2	4	4.0/4.8	1.6 ~ 4.2	0.5 ~ 1.3	5	H	4500
	3	5	5.6/6.4	1.6 ~ 4.2	0.5 ~ 1.3	5	H	4500
F007KD-W522-⑥⑦/FR/STC/⑨	2	4	4.0/4.8	1.6 ~ 4.2	0.5 ~ 1.3	5	H	4500
	3	5	5.6/6.4	1.6 ~ 4.2	0.5 ~ 1.3	5	H	4500



F007K-W522-240/FR/FE/FAC



SMK



STC



鬆緊帶 / 蕾絲鬆緊帶上帶車縫附右切刀

由上送帶裝置，控制長度與張力，附右切刀修布裝置，能於車縫前將布修齊，更能提高車縫品質，如女用內衣褲之鬆緊帶或蕾絲鬆緊帶車縫。

- FFC:** 機械式送帶
- FE:** 簡易電子式送帶
- SMK:** 電子計數器送帶
 - SMK1-C-01 附定位器，適合簡易伺服或離合器馬達
 - SMK1-C-02 以中繼線，連接伺服馬達張力控制式送帶
- STC:** 張力控制式送帶
 - STC1-U-01 附定位器，適合簡易伺服或離合器馬達
 - STC1-U-02 以中繼線，連接伺服馬達張力控制式送帶

ELASTIC / LACE ATTACHING WITH RIGHT FABRIC TRIMMER

Top feeding devices ensure even length and tension controlled by electric digital controller, with right side fabric trimmer for elastic or lace attaching smoothly and properly on women's underwears.

- FFC:** Mechanic type tape feeding.
- FE:** Simple electric type tape feeding.
- SMK:** Electric metering type tape feeding
 - SMK1-C-01 with synchronizer for simple servo motor or clutch motor
 - SMK1-C-02 Connected to servo motor by encoder cable
- STC:** Tension sensor type tape feeding
 - STC1-U-01 with synchronizer for simple servo motor or clutch motor
 - STC1-U-02 Connected to servo motor by encoder cable

選購配件 OPTIONAL DEVICE
FAC, FEC, LF-A, LS-A

規格

SPECIFICATIONS

F007KD-W522-2 40 /FR /FQS/DFKH

規格索引，詳細請參考P.71 Specification index, please refer to P.71

- ① 機種別 Model
- ② 系列 Series
- ③ 網線方式 Covering Types
- ④ 功能 Function
- ⑤ 針板舌片 Needle Plate Finger
- ⑥ 針數 Needle Numbers
- ⑦ 針距 Needle gauge
- ⑧ 配件 Device
- ⑨ 馬達 Motor
H : H Series

F6

F007KD-W522-2⑦/FR/FQS/⑨	2	4	3.2/4.0	1.6 ~ 4.2	0.5 ~ 1.3	5	H	4500



F007KD-W522-240/FR/FQS

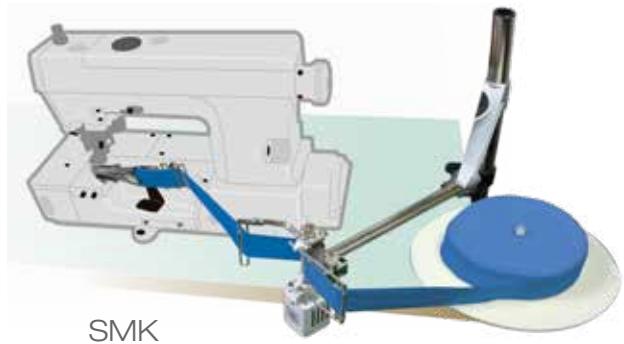

SMK

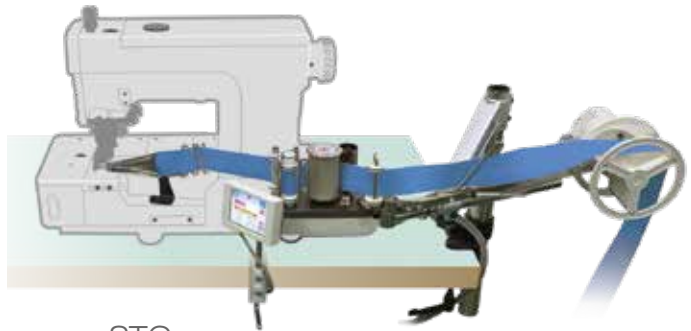

STC

細滾邊車縫 (右切刀機型附側送小喇叭)

本機型適用於女性內褲或丁字褲之細滾邊車縫。在滾邊之前先經右切刀修布，避免發生爆縫問題，可搭配以下送帶裝置

SMK: 電子計數式送帶

- SMK1-E-01 附定位器，適合簡易伺服或離合器馬達
- SMK1-E-02 以中繼線，連接伺服馬達張力控制式送帶

STC: 張力控制式送帶

- STC1-S-01 附定位器，適合簡易伺服或離合器馬達
- STC1-S-02 以中繼線，連接伺服馬達

FINE TAPE BINDING (RIGHT SIDE FABRIC TRIMMER MODEL WITH SMALL BINDER)

This machine is applicable for fine tape binding of women's underwear or T-string. Before tape binding, the fabric edge is trimmed by the right trimmer. This solves the problem of bad binding, which the tape is not sewn on the fabric. The below tape feeding devices are applicable.

SMK: Electric metering type tape feeding

- SMK1-E-01 with synchronizer for simple servo motor or clutch motor
- SMK1-E-02 Connected to servo motor by encoder cable

STC: Tension sensor type tape feeding

- STC1-S-01 with synchronizer for simple servo motor or clutch motor
- STC1-S-02 Connected to servo motor by encoder cable

選購配件 OPTIONAL DEVICE

FAC, FEC, LF-A, LS-A, TUA

規格 SPECIFICATIONS F007KD - U122 - 2 32 /FP /DFKU

規格索引，詳細請參考P.71 Specification index, please refer to P.71

- ① 機種別 Model
- ② 系列 Series
- ③ 網線方式 Covering Types
- ④ 功能 Function
- ⑤ 針板舌片 Needle Plate Finger
- ⑥ 針數 Needle Numbers
- ⑦ 針距 Needle gauge
- ⑧ 配件 Device
- ⑨ 馬達 Motor
U : U Series
H : H Series

F7

F007KD-U122-232/FP/⑨	2	3	3.2	1.6 ~ 4.2	0.5 ~ 1.3	7	H / U	6000



F007KD-U122-232/FP

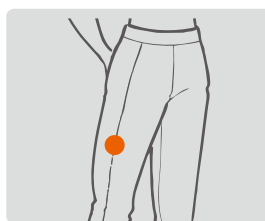

折線條車縫

本機種適用於運動服、牛仔或其他服飾之凸面折線條車縫，車縫時可於折線條內另加縫線繩，以增加凸線條之立體感和裝飾效果。

PINTUCK SEAMING

To sew a decorative convex stripe on sportswears, jeans or other clothes, can also add extra stripe inside convex to increase the effects of convexity and decoration.

F8

F007KD-U613-2⑦/FBP/⑨	2	3	5.6/6.4	1.6 ~ 4.2	0.5 ~ 1.3	7	H / U	6000



F007KD-U613-256/FBP

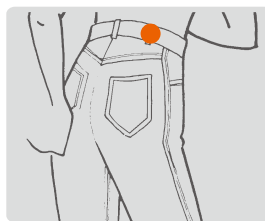

褲耳車縫

利用已裁好之等寬布條連續快速製作褲耳。

BELT-LOOP SEAMING

Mass production for belt loop by using stripped tape.

選購配件 OPTIONAL DEVICE
LF-A , LS-A

規格

SPECIFICATIONS

F007KD -U712A -264 /FSP/DFKU

規格索引，詳細請參考P.71 Specification index, please refer to P.71

- ① 機種別 Model
- ② 系列 Series
- ③ 網線方式 Covering Types
- ④ 功能 Function
- ⑤ 針板舌片 Needle Plate Finger
- ⑥ 針數 Needle Numbers
- ⑦ 針距 Needle gauge
- ⑧ 配件 Device
- ⑨ 馬達 Motor
U : U Series
H : H Series

F9

	⑥	④	⑤	⑦	③	②	⑨	⑧
F007KD-U712(A)-264/FSP/⑨	2	4	6.4	1.6 ~ 4.2	0.5 ~ 1.3	5	H / U	6000
F007KD-U712-496/FSS/⑨	4	6	9.6	1.6 ~ 4.2	0.5 ~ 1.3	5	H / U	6000
F007KD-U712-4111/FSS/⑨	4	6	11.1	1.6 ~ 4.2	0.5 ~ 1.3	5	H / U	6000



F007KD-U712-264/FSP

選購配件 OPTIONAL DEVICE

LF-A, LS-A

布條車縫 (雙針雙勾)

本機系將拷克後之拷克骨縫上布條以補強及增加美觀之用，如男內褲、休閒褲等之車縫。

U712: 成品寬度10mm

U712A: 成品寬度12mm

TAPE ATTACHING (TWO NEEDLE, TWO LOOPER)

This machine is specially for tape binding on cross seaming of men's briefs or sportswears to strengthen plain seam and for ornamental purpose.

U712: finished tape width 10mm

U712A: finished tape width 12mm

布條車縫 (四針雙勾)

本機系將拷克後之拷克骨縫上布條以補強及增加美觀之用，如男內褲、休閒褲等之車縫。

TAPE ATTACHING (FOUR NEEDLE, TWO LOOPER)

This machine is specially for tape binding on cross seaming of men's briefs or sportswears to strengthen plain seam and for ornamental purpose.

F10

	⑥	④	⑤	⑦	③	②	⑨	⑧
F007KD-U712-264/FSR/⑨	2	4	6.4	1.6 ~ 4.2	0.5 ~ 1.3	5	H / U	6000



F007KD-U712-264/FSR

捲疊縫

本機種設計特殊之左右齒差動方式，能使捲疊縫縫紉更順暢車縫後左右二片布均一無長短之虞，適用於西褲、休閒褲、牛仔褲薄至厚布料等之捲邊疊縫。

LAP SEAMING

Differential ratio of left and right feed dog can be adjusted separately for lap seaming to ensure symmetrical length to both left and right fabric. Applicable to trousers, casual pants and jeans, etc...

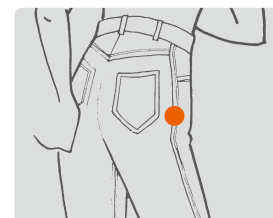

規格 SPECIFICATIONS F007KD - W722 - 3 88 /FY /DFKU

規格索引，詳細請參考P.71 Specification index, please refer to P.71

- ① 機種別 Model
- ② 系列 Series
- ③ 網線方式 Covering Types
- ④ 功能 Function
- ⑤ 針板舌片 Needle Plate Finger
- ⑥ 針數 Needle Numbers
- ⑦ 針距 Needle gauge
- ⑧ 配件 Device
- ⑨ 馬達 Motor
U : U Series
H : H Series

F11

F007KD-W722-388/FY/⑨	3	7	8.8	1.6 ~ 4.2	0.5 ~ 1.3	5	H / U	6000



F007KD-W722-388/FY

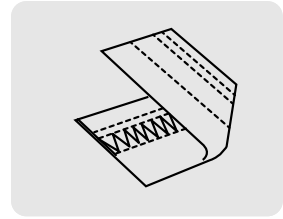
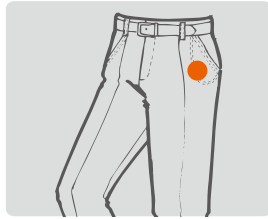

褲袋裡車縫

本機為三針三勾針一上叉，可同時縫合褲袋內裡與表布並強化車縫處之牢固，增加美觀提高效率，適用於西褲、工作褲等。

POCKET LINING SEAMING

This is a 3 needles 3 loopers 1 spreader machine, and special for seaming the shell fabric and lining of pocket in trousers or work pants in simple operation to increase sewing quality and efficiency.

F12

F007KD-W922-456/FW/⑨	4	6	5.6	1.6 ~ 4.2	0.5 ~ 1.3	5	H / U	6000
F007KD-W922-460/FW/⑨	4	6	6.0	1.6 ~ 4.2	0.5 ~ 1.3	5	H / U	6000
F007KD-W922-464/FW/⑨	4	6	6.4	1.6 ~ 4.2	0.5 ~ 1.3	5	H / U	6000



F007KD-W922-456/FW

四針六線搭接縫車縫

適用於一般內衣褲二片布接縫處之接縫和補強，附有專屬之導邊，可使二片布順暢縫合。

FOUR-NEEDLE FLAT SEAMING

For flat seaming 2 pieces of fabric. Equipped with fabric guide for easy operation.

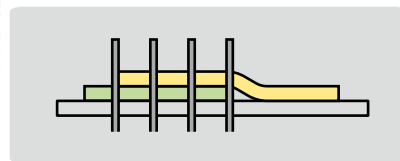

選購配件	OPTIONAL DEVICE
	UTH, UTK

FW- 4	四針，無假針，適用上網線切線刀 4 needles Without retainer, applicable to upper thread trimmer
FW- 4A	配特殊針板 E1838P，適合車縫運動鞋裝飾線 With special needle plate E1838P, applicable to shoe decoration
FW- 5	四針，有假針，不適用上網線切線刀 4 needles with retainer, not applicable to upper thread trimmer

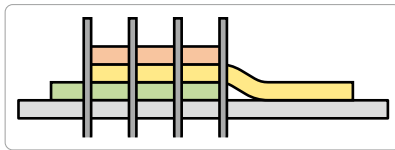

FWP

附喇叭 (B417R) 與導帶架

With folder (B417R) and tape guide.

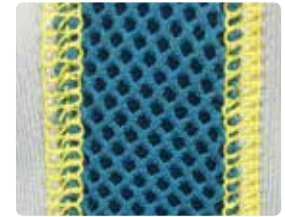
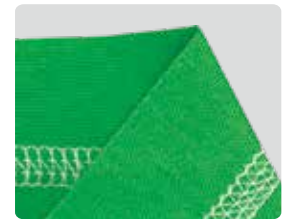
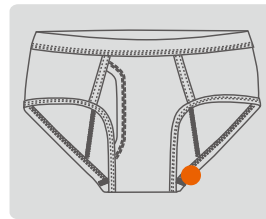

FW-4A

規格

SPECIFICATIONS

F007KD - W121 - 2 40/ FFT/ FHA/ DFKU

規格索引，詳細請參考P.71 Specification index, please refer to P.71

- ① 機種別 Model
- ② 系列 Series
- ③ 網線方式 Covering Types
- ④ 功能 Function
- ⑤ 針板舌片 Needle Plate Finger
- ⑥ 針數 Needle Numbers
- ⑦ 針距 Needle gauge
- ⑧ 配件 Device
- ⑨ 馬達 Motor
U : U Series
H : H Series

F13

	⑥		mm	⑦	mm		mm		⑨	S.P.M. (Max)
F007KD-W121-⑥⑦/FFT/FHA⑨	2	4	4.0/ 4.8	1.6 ~ 4.2	0.5 ~ 1.3	1~5.5	5	H / U	4500	
	3	5	5.6/ 6.4	1.6 ~ 4.2	0.5 ~ 1.3	1~5.5	5	H / U	4500	
F007KD-W122-⑥⑦/FFT/FHA⑨	2	4	4.0/ 4.8	1.6 ~ 4.2	0.5 ~ 1.3	1~5.5	5	H / U	4500	
	3	5	5.6/ 6.4	1.6 ~ 4.2	0.5 ~ 1.3	1~5.5	5	H / U	4500	
F007KD-W131-⑥⑦/FFT/FHA⑨	2	4	4.0/ 4.8	1.6 ~ 4.2	0.5 ~ 1.3	1~5.5	5	H / U	4500	
	3	5	5.6/ 6.4	1.6 ~ 4.2	0.5 ~ 1.3	1~5.5	5	H / U	4500	
F007KD-W132-⑥⑦/FFT/FHA⑨	2	4	4.0/ 4.8	1.6 ~ 4.2	0.5 ~ 1.3	1~5.5	5	H / U	4500	
	3	5	5.6/ 6.4	1.6 ~ 4.2	0.5 ~ 1.3	1~5.5	5	H / U	4500	



FFT 上送布功能

專利優化前後移動送具之結構設計，有效送布行程大，車縫送布更穩定。

FFT TOP FEEDING FUNCTION

Back and forth moving feed dog is designed by patent and improved mechanism. The effective feeding stroke is bigger, and fabric feeding is more stable.

選購配件 OPTIONAL DEVICE
UTG, UTJ

