

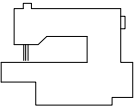

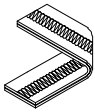

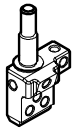

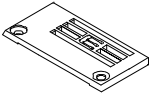

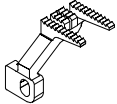
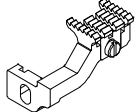
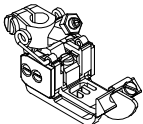



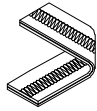
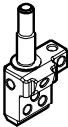
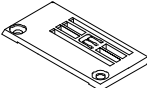
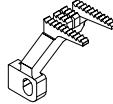
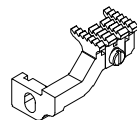
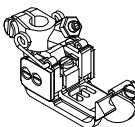



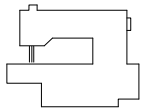
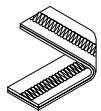
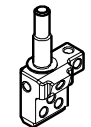
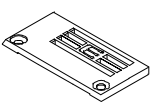
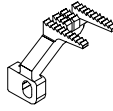
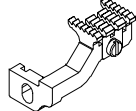
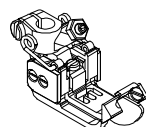
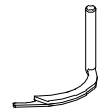
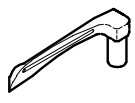

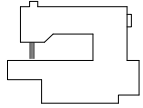
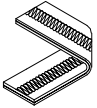
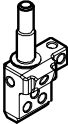
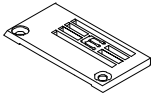
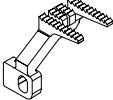
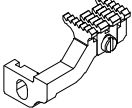
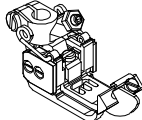

SIRUBA GAGE PARTS LIST	Series			Remark						Page	Date
	C007KP									1 / 6	2021/12/16
											
MODEL	SUB-CLASS	NEEDLE CLAMP	NEEDLE PLATE	MAIN FEED DOG	DIFF. FEED DOG	PRESSER FOOT	SPREADER	LOOPER	NEEDLE		
機 型	規 格	針 座	針 板	主 送 具	差 送 具	押 具	上 叉	勾 針	針 號		
W121/CH	232 240 248 348	M5232 M5240 M5248 M5348KX	E5232KL E5240EL E5248EL E5348KL E5356EL E5364EL	D5356K	H5356KA-E	P5232A-A P2544-A P2545-A P5348A-A P2446-A P2447-A	MH41	MT01	UYX128GAS#9		
W122/CH	356 364	M5356 M5364	E5232KM E5240EM E5248EM E5348KM E5356EM E5364EM						UYX128GAS#10		
W122/CH-3M	356 364	M5356 M5364	E5356EM E5364EM	D5356K	H5356KA-E	P2456-A P2457-A	MH41	MT01	UYX128GAS#10		
W123/CH	232 240 248 348 356 364	M5232 M5240 M5248 M5348KX M5356 M5364	E5232KH E5240KH E5248KH E5348KH E5356KH E5364KH	D5356K	H5356KA-E	P5232A-A P2544-A P2545-A P5348A-A P2446-A P2447-A	MH41	MT01	UYX128GAS#10		
W152/CZ/UTP/RLQ	356 364	M5356 M5364	E5356GM E5364GM	D5356G	H5356L	P2416-A P2417-A	MH41	MT01	UYX128GAS#10		
W152/CZP/RLQ											
W162/CH	240 248 348 356 364	M5240 M5248 M5348KX M5356 M5364	E5240KHA E5248KHA E5348KHA E5356KHA E5364KHA	D5356K	H5356KA-E	P2544-A P2545-A P5348A-A P2446-A P2447-A	MH41	MT01A	TV*5#14~16		

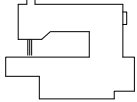
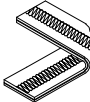
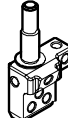
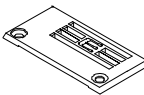
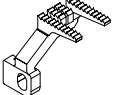
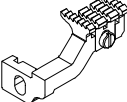
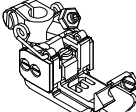
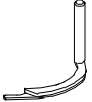
SIRUBA MODEL COMPARE LIST		Series				Remark				Page	Date
		C007KP								2 / 6	2023/1/10
											
MODEL	SUB-CLASS	NEEDLE CLAMP	NEEDLE PLATE	MAIN FEED DOG	DIFF. FEED DOG	PRESSER FOOT	SPREADER	LOOPER	NEEDLE		
機 型	規 格	針 座	針 板	主 送 具	差 送 具	押 具	上 叉	勾 針	針 號		
W222/CQ	240 248 356 364	M5240 M5248 M5356 M5364	E5240GM E5248GM E5356GM E5364GM	D5356G	H5356GA	P1814K-A P1815K-A P2116K-A P2117K-A	MH41	MT01	UYX128GAS#10		
W322/CC	356 364	M5356	E5356AML E5364AML	D5356K	H5356AA	P2456-A P2457-A	MH41	MT01	UYX128GAS#10		
W322/CE		M5364	E5356BML E5364BML		H5356BA						
W522/CR	232 240 248 348 356 364	M5232 M5240 M5248 M5348KX	E5232CML E5240CML E5248CML E5348CH	D5356C	H5356CA	P5232R-A P5240R-A P5248R-A P5348R-A P5356R-A P5364R-A	MH41	MT01	UYX128GAS#10		
W532/CR/UTP/CL/RLP1/CX		M5356 M5364	E5356CML E5364CML								
W811/CRL	232 240 248 356 364	M5232 M5240 M5248	E5232ML E5240ML E5248ML	D5356H	H5356MA	P2763-A P2764-A P2765-A P2766-A P2767-A	MH41	MT01	UYX128GAS#9		
U811/CRL		M5356 M5364	E5356ML E5364ML			P0963-A P0964-A P0965-A P0966-A P0967-A					

SIRUBA GAGE PARTS LIST	Series		Remark							Page	Date
	C007KP									3 / 6	2020/11/3
											
MODEL	SUB-CLASS	NEEDLE CLAMP	NEEDLE PLATE	MAIN FEED DOG	DIFF. FEED DOG	PRESSER FOOT	SPREADER	LOOPER	NEEDLE		
機 型	規 格	針 座	針 板	主 送 具	差 送 具	押 具	上 叉	勾 針	針 號		
W811A/CRL	232 240 248	M5232 M5240 M5248	E5232NL E5240NL E5248NL	D5356H	H5356NA	P2763-A P2764-A P2765-A P2766-A P2767-A	MH41	MT01	UYX128GAS#9		
U811A/CRL	356 364	M5356 M5364	E5356NL E5364NL			P0963-A P0964-A P0965-A P0966-A P0967-A	—				
W812/CRL	232 240 248	M5232 M5240 M5248	E5232QLL E5240QLL E5248QLL	D5356H	H5356MA	P2763-A P2764-A P2765-A P2766-A P2767-A	MH41	MT01	UYX128GAS#10		
U812/CRL	356 364	M5356 M5364	E5356QLL E5364QLL			P0963-A P0964-A P0965-A P0966-A P0967-A	—				
W812A/CRL	232 240 248	M5232 M5240 M5248	E5232RLL E5240RLL E5248RLL	D5356H	H5356NA	P2763-A P2764-A P2765-A P2766-A P2767-A	MH41	MT01	UYX128GAS#10		
U812A/CRL	356 364	M5356 M5364	E5356RLL E5364RLL			P0963-A P0964-A P0965-A P0966-A P0967-A	—				

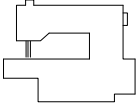
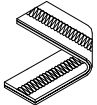
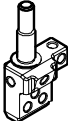
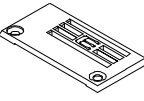
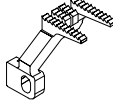
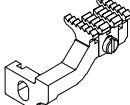
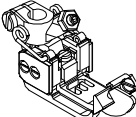
SIRUBA MODEL COMPARE LIST		Series				Remark				Page	Date
		C007KP				W812 /W813 : 4rof teeth W812A/W813A : 5rof teeth				4 / 6	2020/11/3
											
MODEL	SUB-CLASS	NEEDLE CLAMP	NEEDLE PLATE	MAIN FEED DOG	DIFF. FEED DOG	PRESSER FOOT	SPREADER	LOOPER	NEEDLE		
機 型	規 格	針 座	針 板	主送具	差送具	押 具	上 叉	勾 針	針 號		
W813/CRL	232 240 248	M5232 M5240 M5248	E5232MH E5240MH E5248MH	D5356H	H5356MA	P2763-A P2764-A P2765-A P2766-A P2767-A	MH41	MT01	UYX128GAS#10		
U813/CRL	356 364	M5356 M5364	E5356MH E5364MH			P0963-A P0964-A P0965-A P0966-A P0967-A	—				
W813A/CRL	232 240 248	M5232 M5240 M5248	E5232NH E5240NH E5248NH	D5356H	H5356NA	P2763-A P2764-A P2765-A P2766-A P2767-A	MH41	MT01	UYX128GAS#10		
U813A/CRL	356 364	M5356 M5364	E5356NH E5364NH			P0963-A P0964-A P0965-A P0966-A P0967-A	MH41				
W821/CRL/CHP/UTP/CL/RL	232 240 248	M5232 M5240 M5248	E5232ML E5240ML E5248ML	D5356H	H5356MA	P2763-A P2764-A P2765-A P2766-A P2767-A	—	MT01	UYX128GAS#9		
U821/CRL/CHP/UTP/CL/RL	356 364	M5356 M5364	E5356ML E5364ML			P0963-A P0964-A P0965-A P0966-A P0967-A	—				

SIRUBA MODEL COMPARE LIST	Series				Remark				Page	Date
	C007KP				W812 /W813 : 4rof teeth W812A/W813A : 5rof teeth				5 / 6	2020/11/3
										
MODEL	SUB-CLASS	NEEDLE CLAMP	NEEDLE PLATE	MAIN FEED DOG	DIFF. FEED DOG	PRESSER FOOT	SPREADER	LOOPER	NEEDLE	
機 型	規 格	針 座	針 板	主送具	差送具	押 具	上 叉	勾 針	針 號	
W821A/CRL/CHP/UTP/CL/RL	232 240 248	M5232 M5240 M5248	E5232NL E5240NL E5248NL	D5356H	H5356NA	P2763-A P2764-A P2765-A P2766-A P2767-A	MH41	MT01	UYX128GAS#9	
U821A/CRL/CHP/UTP/CL/RL	356 364	M5356 M5364	E5356NL E5364NL			P0963-A P0964-A P0965-A P0966-A P0967-A	—			
W822/CRL/CHP/UTP/CL/RL	232 240 248	M5232 M5240 M5248	E5232QLL E5240QLL E5248QLL	D5356H	H5356MA	P2763-A P2764-A P2765-A P2766-A P2767-A	MH41	MT01	UYX128GAS#10	
U822/CRL/CHP/UTP/CL/RL	356 364	M5356 M5364	E5356QLL E5364QLL			P0963-A P0964-A P0965-A P0966-A P0967-A	—			
W822A/CRL/CHP/UTP/CL/RL	232 240 248	M5232 M5240 M5248	E5232RLL E5240RLL E5248RLL	D5356H	H5356NA	P2763-A P2764-A P2765-A P2766-A P2767-A	MH41	MT01	UYX128GAS#10	
U822A/CRL/CHP/UTP/CL/RL	356 364	M5356 M5364	E5356RLL E5364RLL			P0963-A P0964-A P0965-A P0966-A P0967-A	—			

SIRUBA GAGE PARTS LIST	Series					Remark				Page	Date
	C007KP									6 / 6	2020/11/3
											
MODEL	SUB-CLASS	NEEDLE CLAMP	NEEDLE PLATE	MAIN FEED DOG	DIFF. FEED DOG	PRESSER FOOT	SPREADER	LOOPER	NEEDLE		
機 型	規 格	針 座	針 板	主送具	差送具	押 具	上 叉	勾 針	針 號		
W823/CRL/CHP/UTP/CL/RL	232 240 248 356 364	M5232 M5240 M5248 M5356 M5364	E5232MH E5240MH E5248MH E5356MH E5364MH	D5356H	H5356MA	P2763-A P2764-A P2765-A P2766-A P2767-A	MH41	MT01	UYX128GAS#10		
U823/CRL/CHP/UTP/CL/RL						P0963-A P0964-A P0965-A P0966-A P0967-A				—	
W823A/CRL/CHP/UTP/CL/RL	232 240 248 356 364	M5232 M5240 M5248 M5356 M5364	E5232NH E5240NH E5248NH E5356NH E5364NH	D5356H	H5356NA	P2763-A P2764-A P2765-A P2766-A P2767-A	MH41	MT01	UYX128GAS#10		
U823A/CRL/CHP/UTP/CL/RL						P0963-A P0964-A P0965-A P0966-A P0967-A				—	
W922/CW	456 460 464	M5456K M5460K M5464K	E5456KM E5460KM E5464KM	D5456K	H5456KA-E	P5456K-A P5460K-A P5464K-A	MH41	MT01B	SM1014B#10		

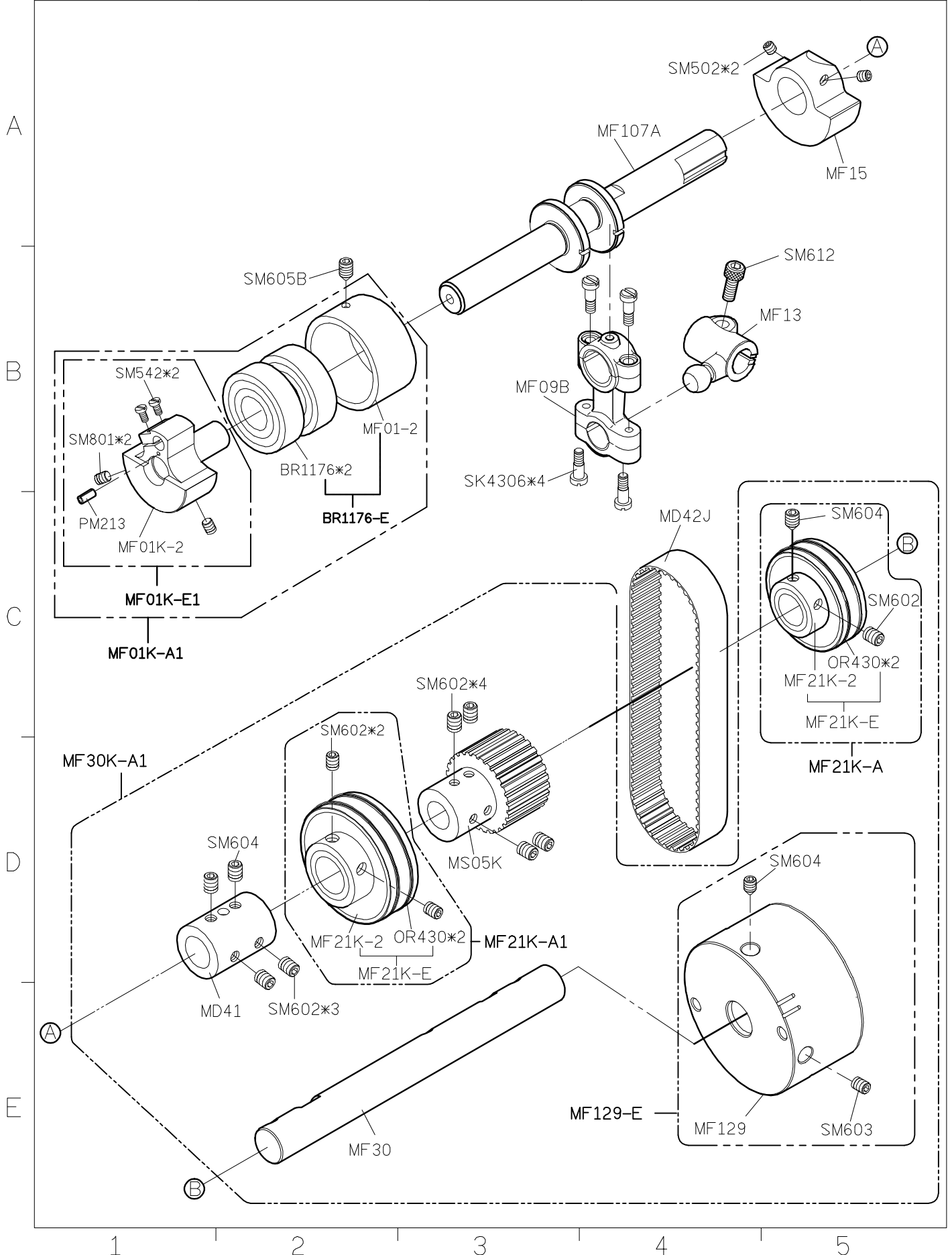

SIRUBA PARTS LIST	Series	Parts Group	Subclass / Remark	Page
	C007K/C007KD	MG-K		1/1
	C007KP/C858K			Date
				2021/7/19

A

B

C

D

E

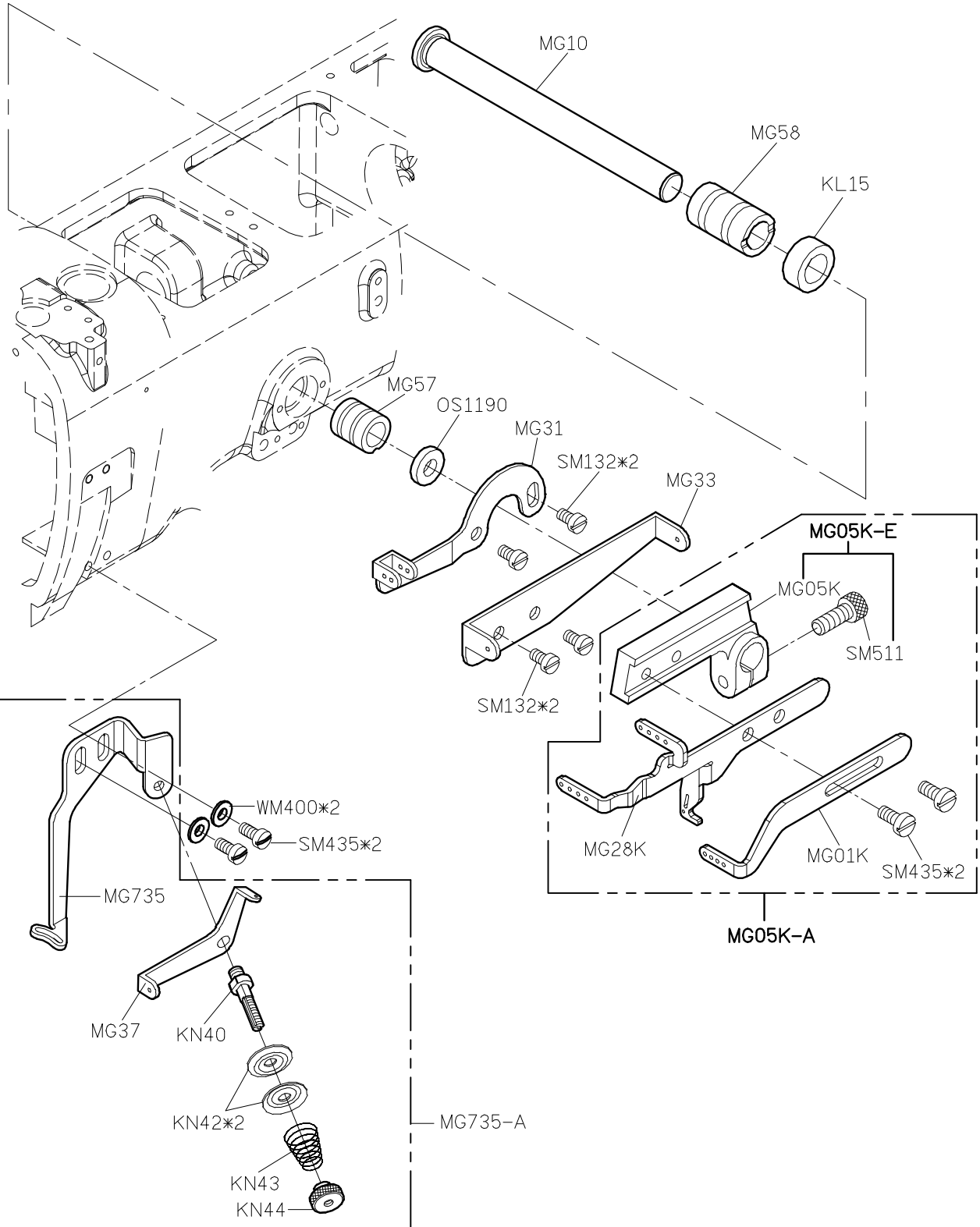

1

2

3

4

5

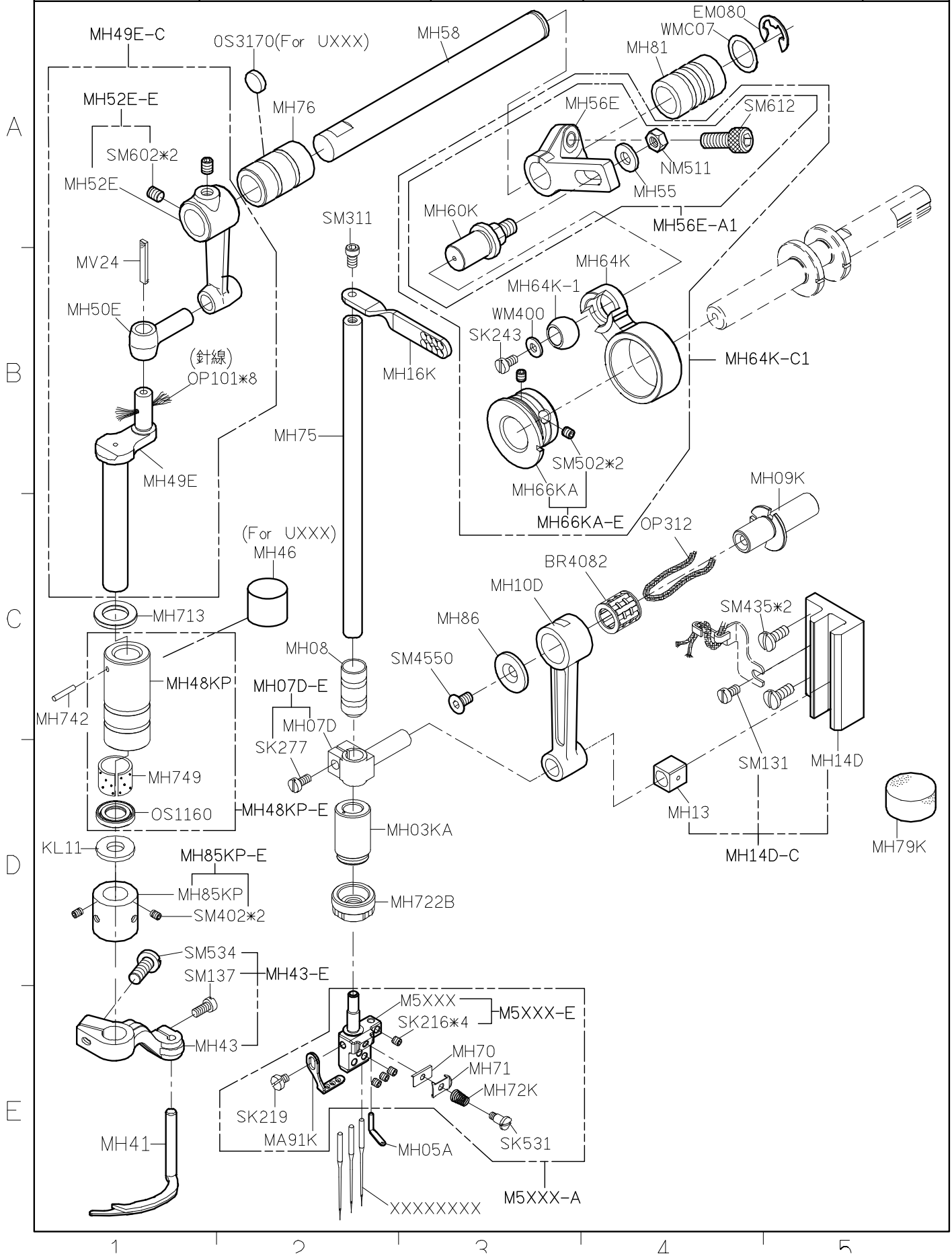

組件代號	零件內容
MJ35K-A3	MJ35K/MJ38/NM610
MJ35K-A5	MJ35K/MJ238/NM610 MJ54K/SM492

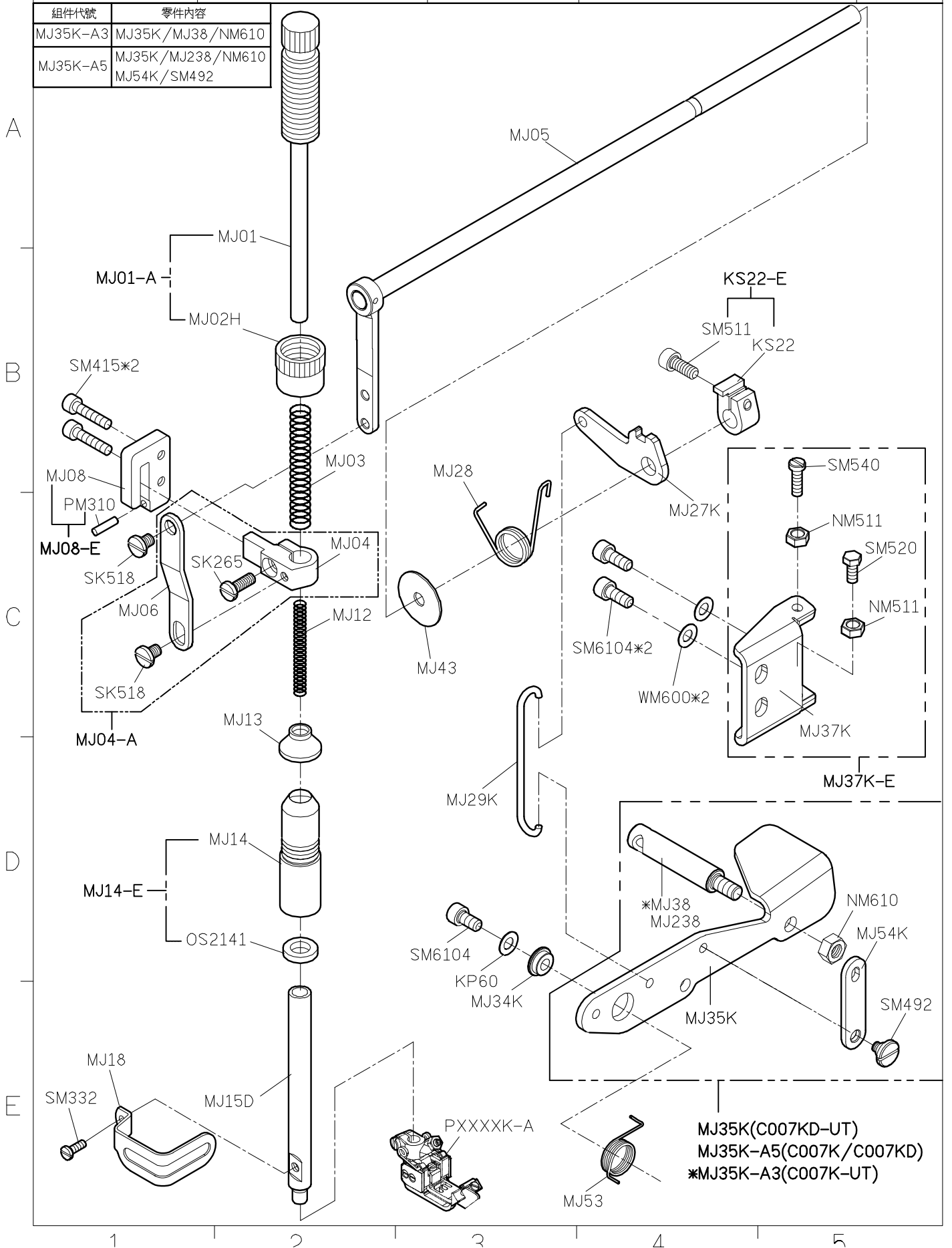

SIRUBA PARTS LIST	Series	Parts Group	Subclass / Remark	Page
	C007K/C007KD C007JP/C007KP C858K	MK-K	*:Use for C007KP	1/1
				Date 2020/3/20

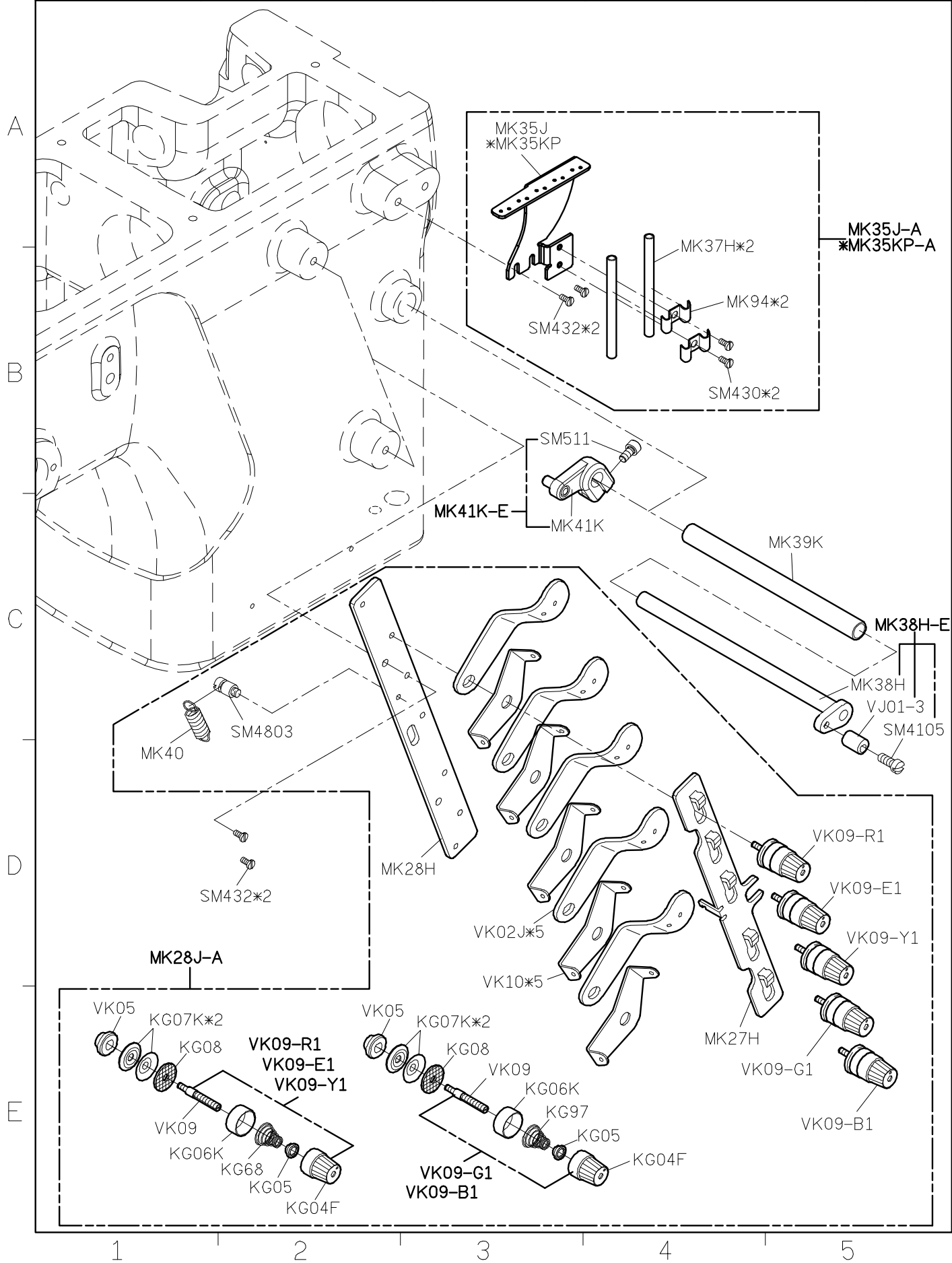

SiRUBA PARTS LIST	Series	Parts Group	Subclass / Remark	Page
	C007K/C007KD	MN-K		1/3
	C007JP/C007KP			Date
	C858K			2019/08/08

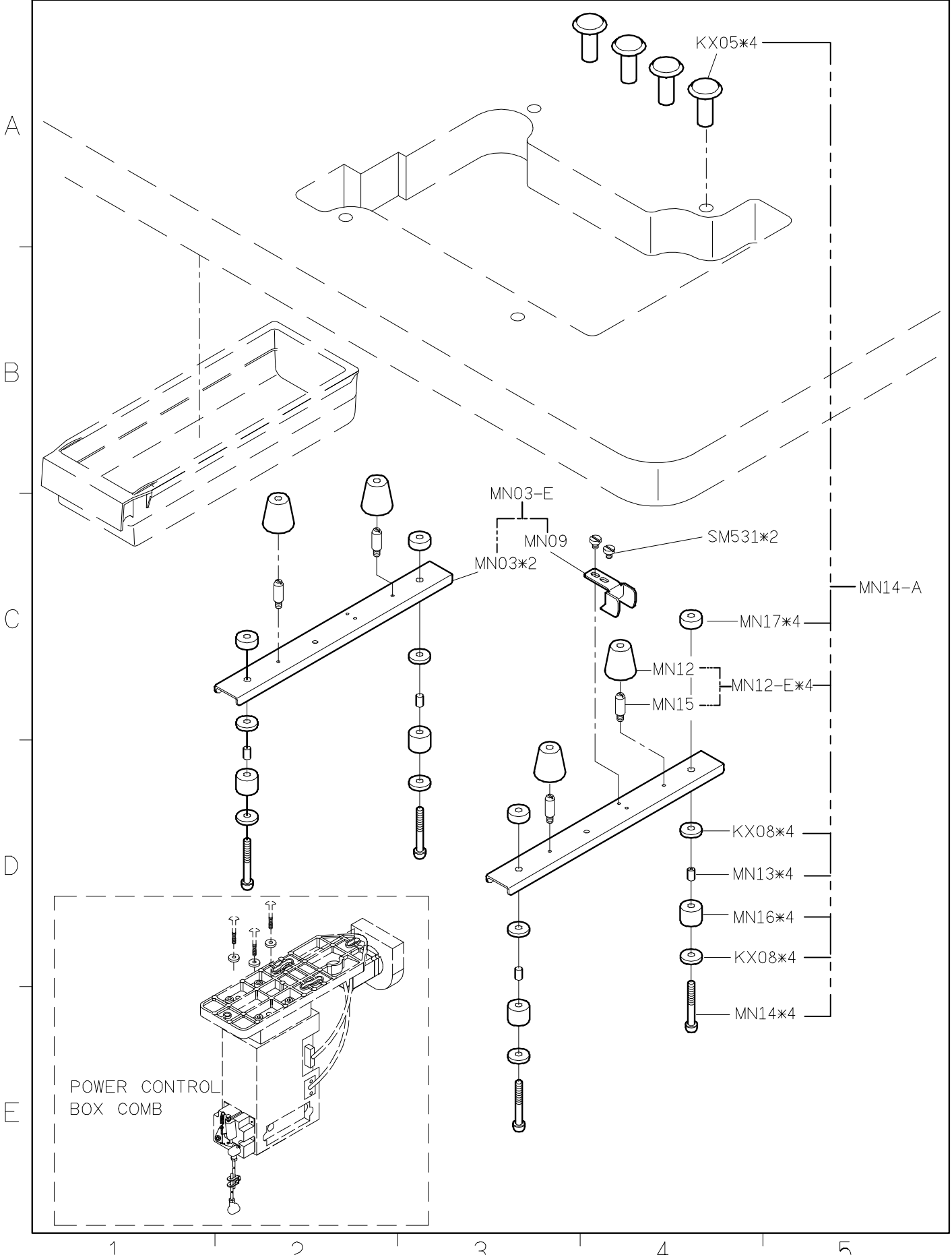

SIRUBA PARTS LIST	Series	Parts Group	Subclass / Remark	Page
	C007K/C007KD	MN-K	△ Use for C007JP	2/3
	C007JP/C007KP			Date
	C858K			2019/08/08

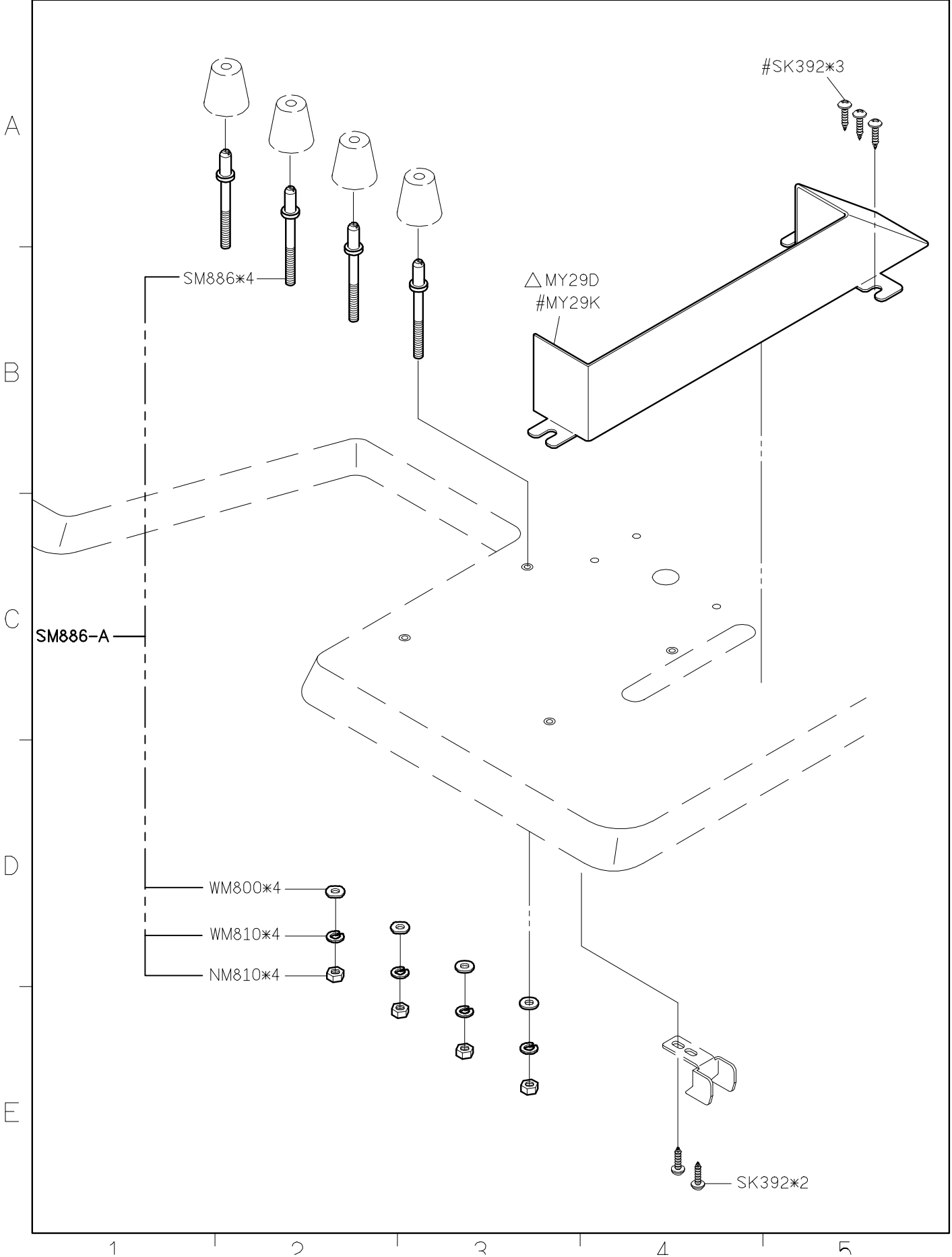

SIRUBA PARTS LIST	Series	Parts Group	Subclass / Remark	Page
	C007KP	MN-K	*Use For Direct-Drive Motor (P牌 /U牌) #For Option	3/3
				Date 2020/4/28

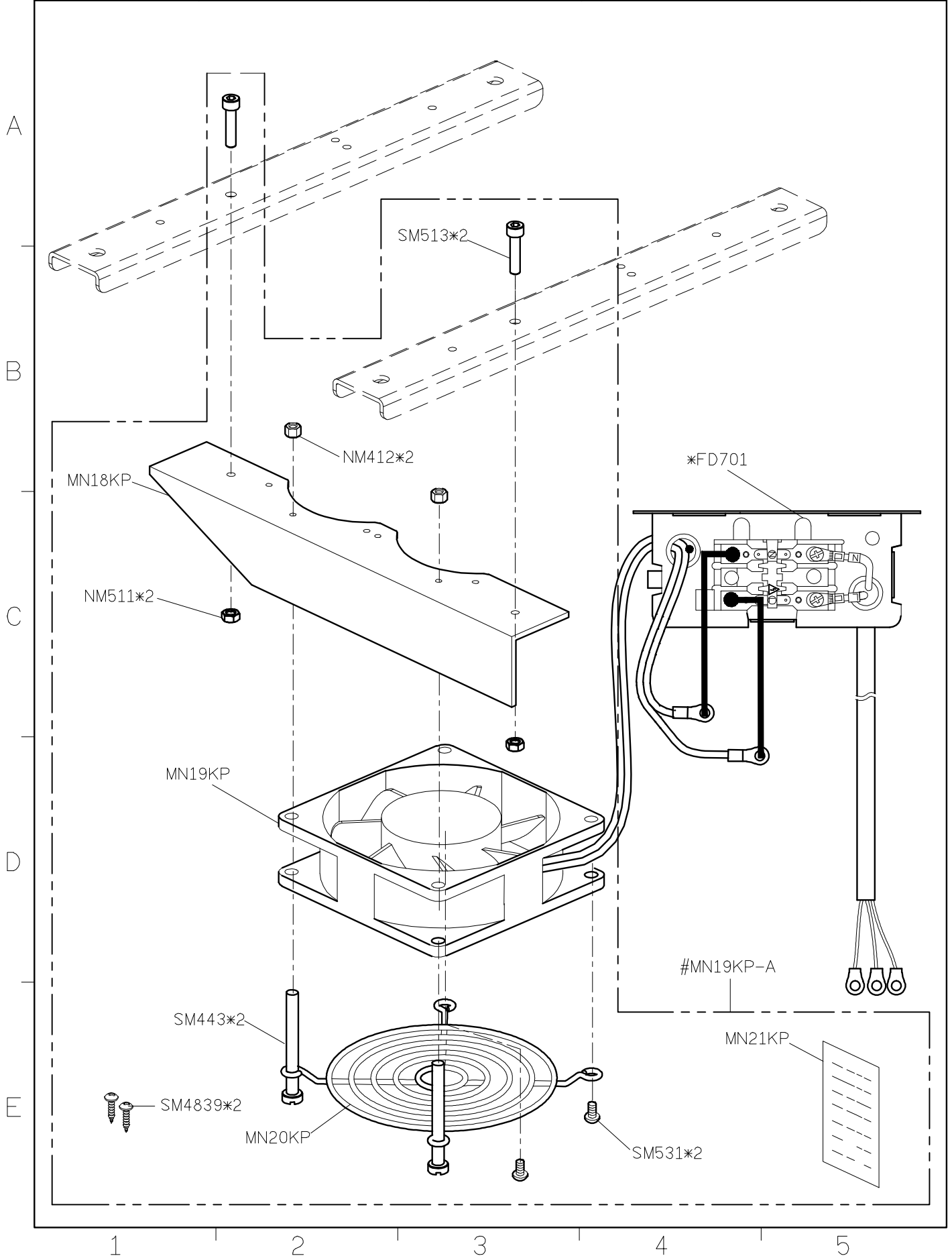

SIRUBA PARTS LIST	Series	Parts Group	Subclass / Remark	Page
	C007KD/C007KP	MQ-K	For Direct-Drive Motor (H牌) #For Pneumatic Automatic %For Electric Automatic &For Pneumatic Automatic(TD) *For Electric Automatic(TD)	2/7
				Date
				2024/1/4

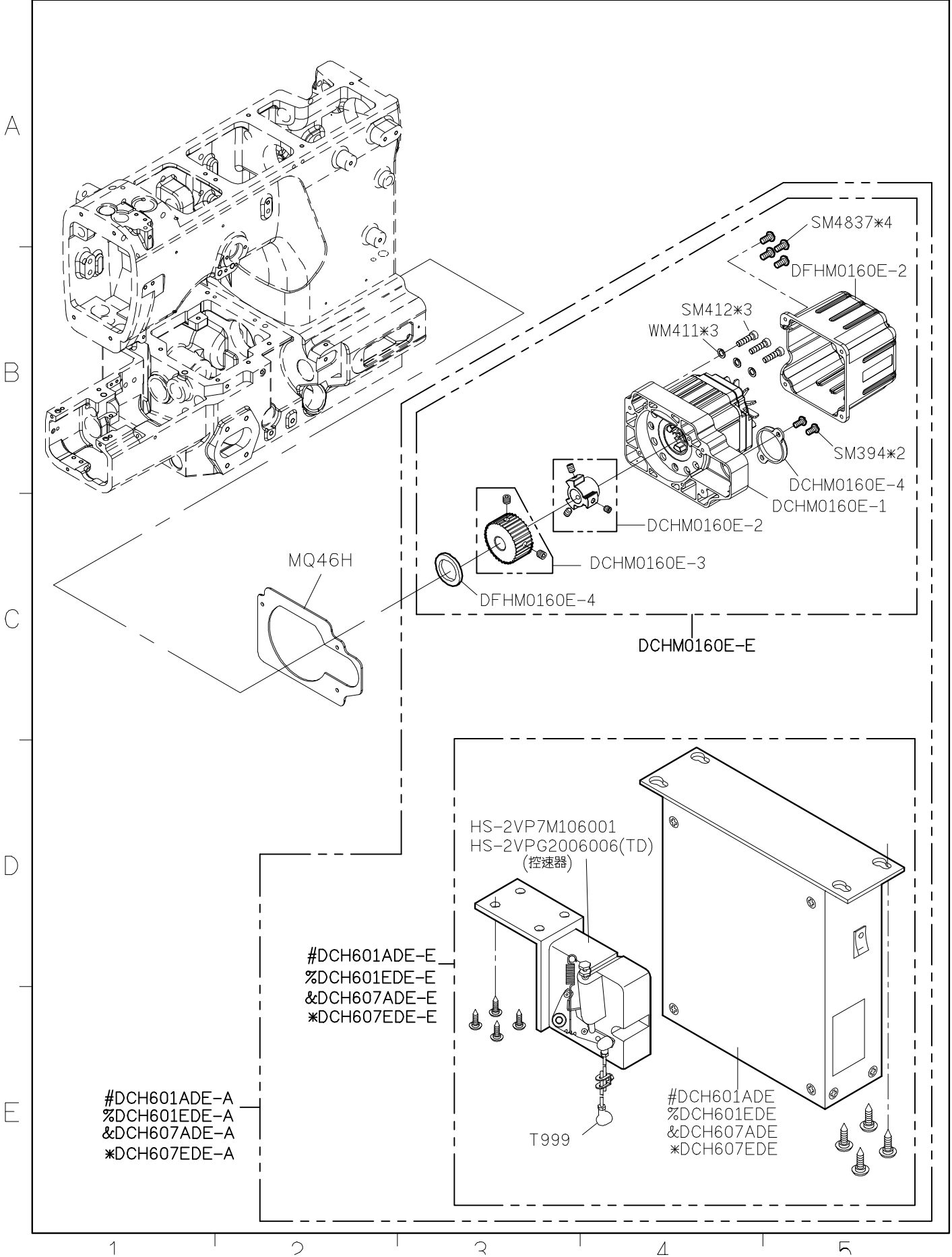

料號	BOM
DFTM0160E-2-E	DFTM0160E-2*1 DCTM0160E-3*1 SM4846*4 WM411*3 SM412*3

A

B

C

D

E

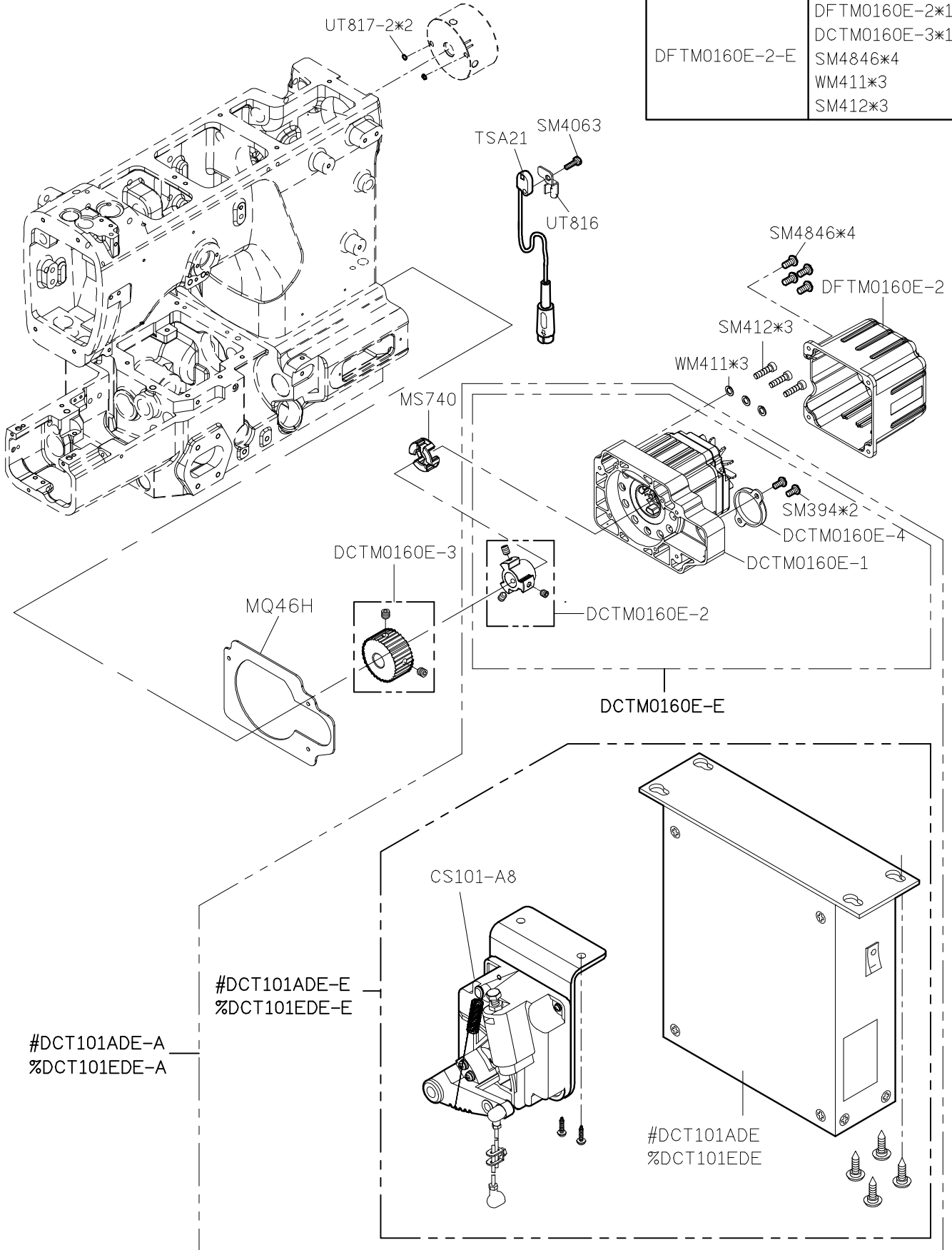

1

2

3

4

5

SIRUBA PARTS LIST	Series	Parts Group	Subclass / Remark	Page
	C007KD/C007KP	MQ-K	For Direct-Drive Motor (P牌) #For Pneumatic Automatic %For Electric Automatic	4/7
				Date
				2024/1/4

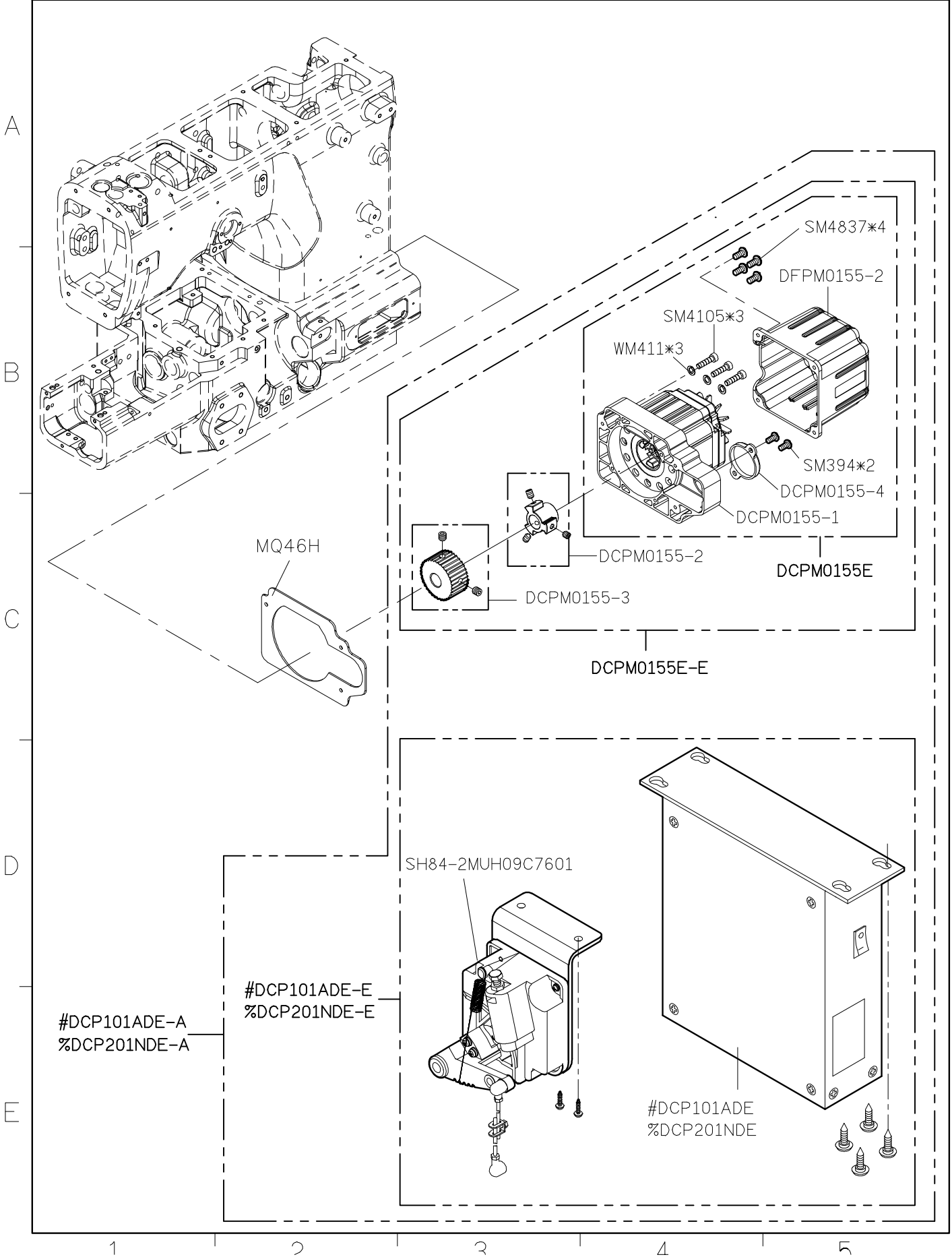

1

2

3

4

5

SIRUBA PARTS LIST	Series	Parts Group	Subclass / Remark	Page
	C007KD/C007KP	MQ-K	For Direct-Drive Motor (U牌)	5/7
				Date
				2024/1/4

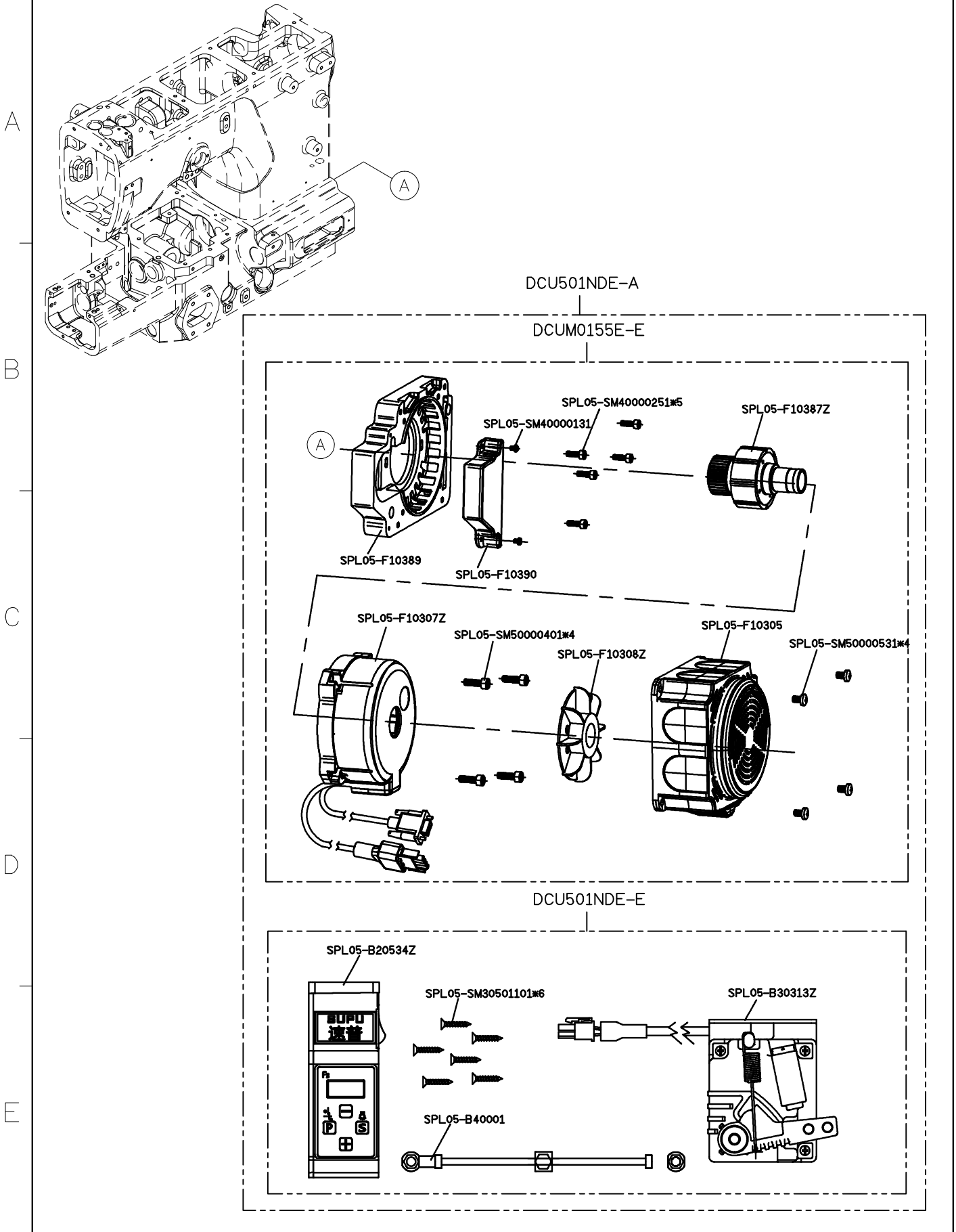

1

2

3

4

5

SIRUBA PARTS LIST	Series	Parts Group	Subclass / Remark	Page
	C007KD/C007KP	MQ-K	For Direct-Drive Motor #For Pneumatic Automatic %For Electric Automatic	6/7
				Date
				2024/1/4

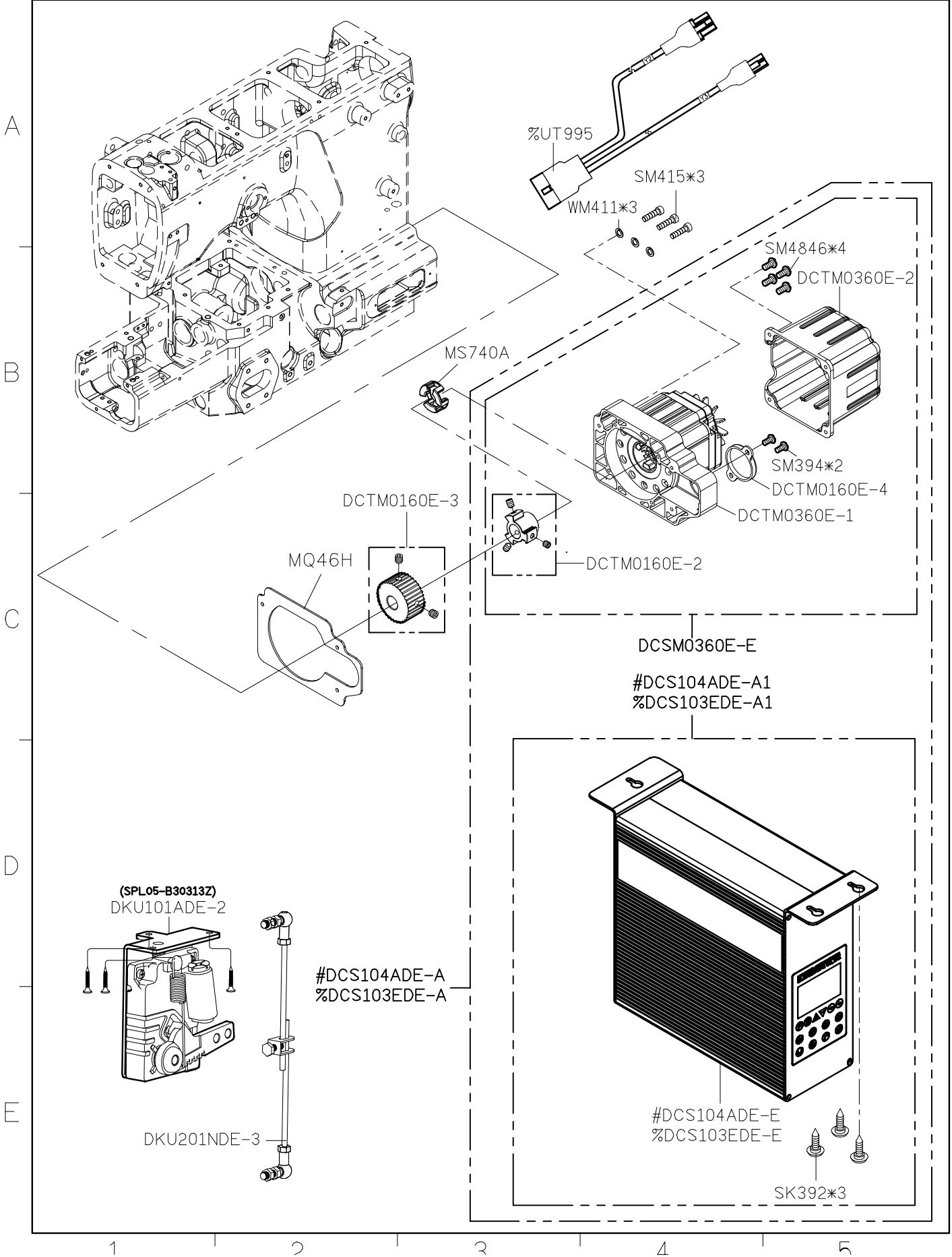

SIRUBA PARTS LIST	Series	Parts Group	Subclass / Remark	Page
	C858KD	MQ-K		7/7
				Date
				2024/1/4

A

B

C

D

E

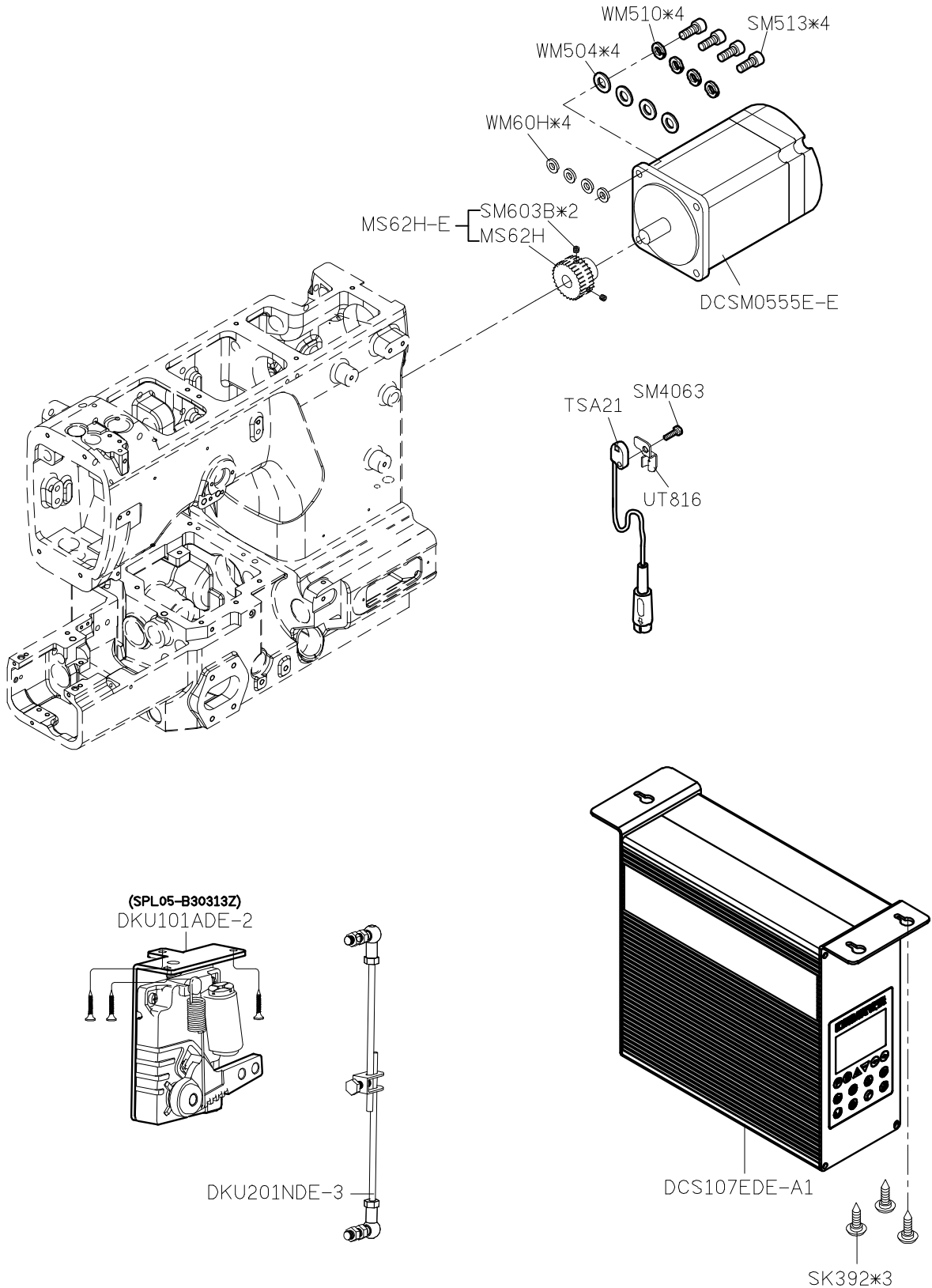

1

2

3

4

5

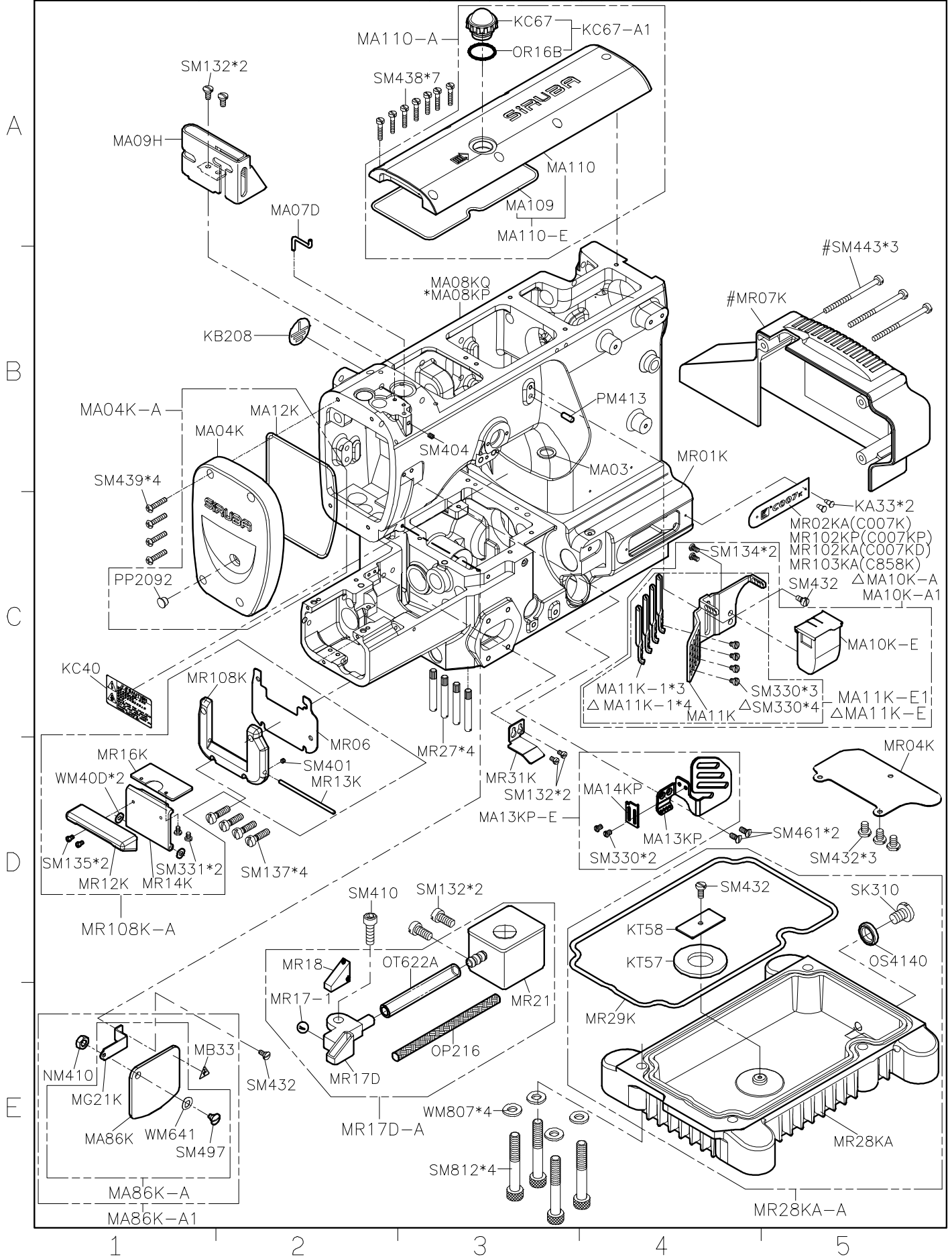

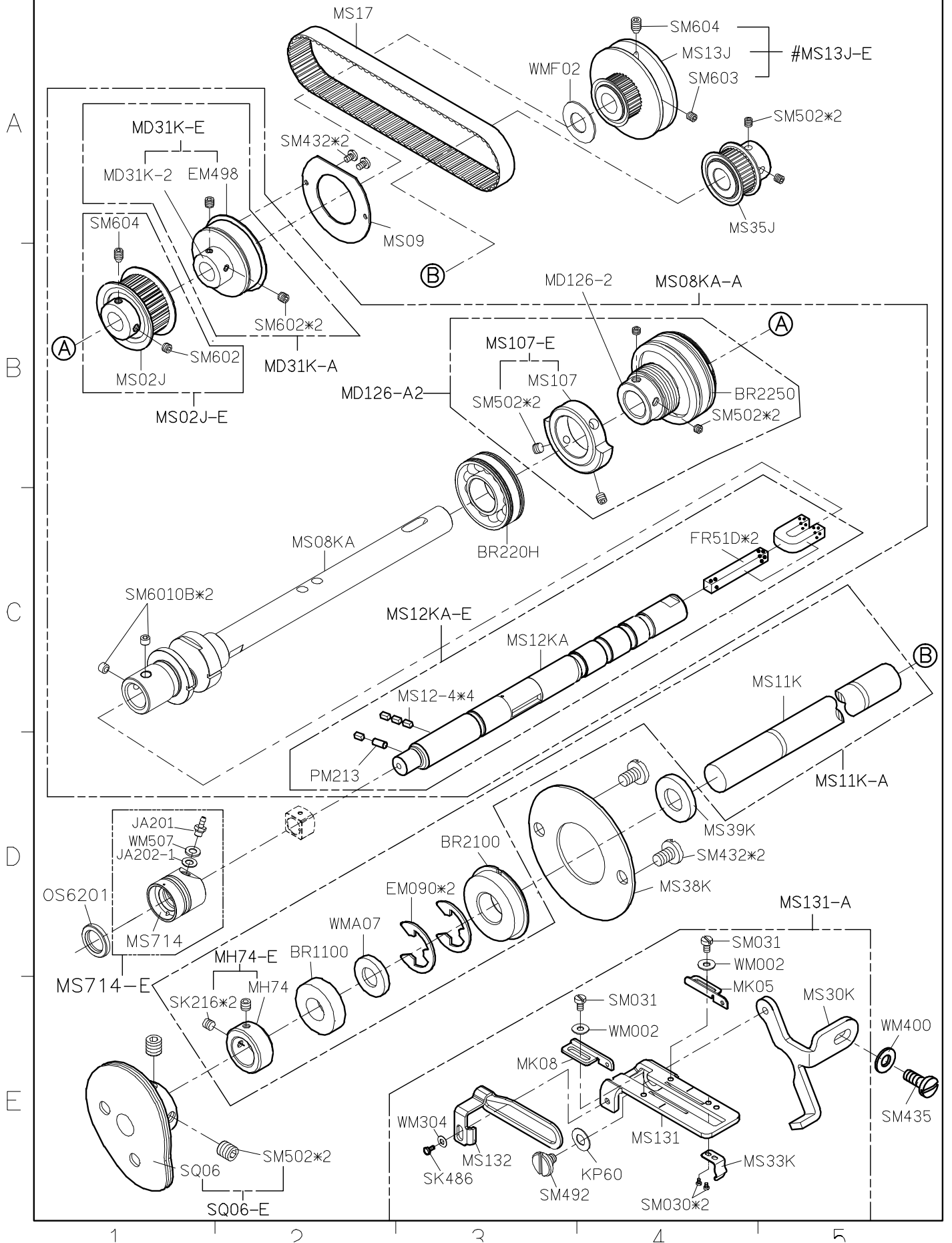

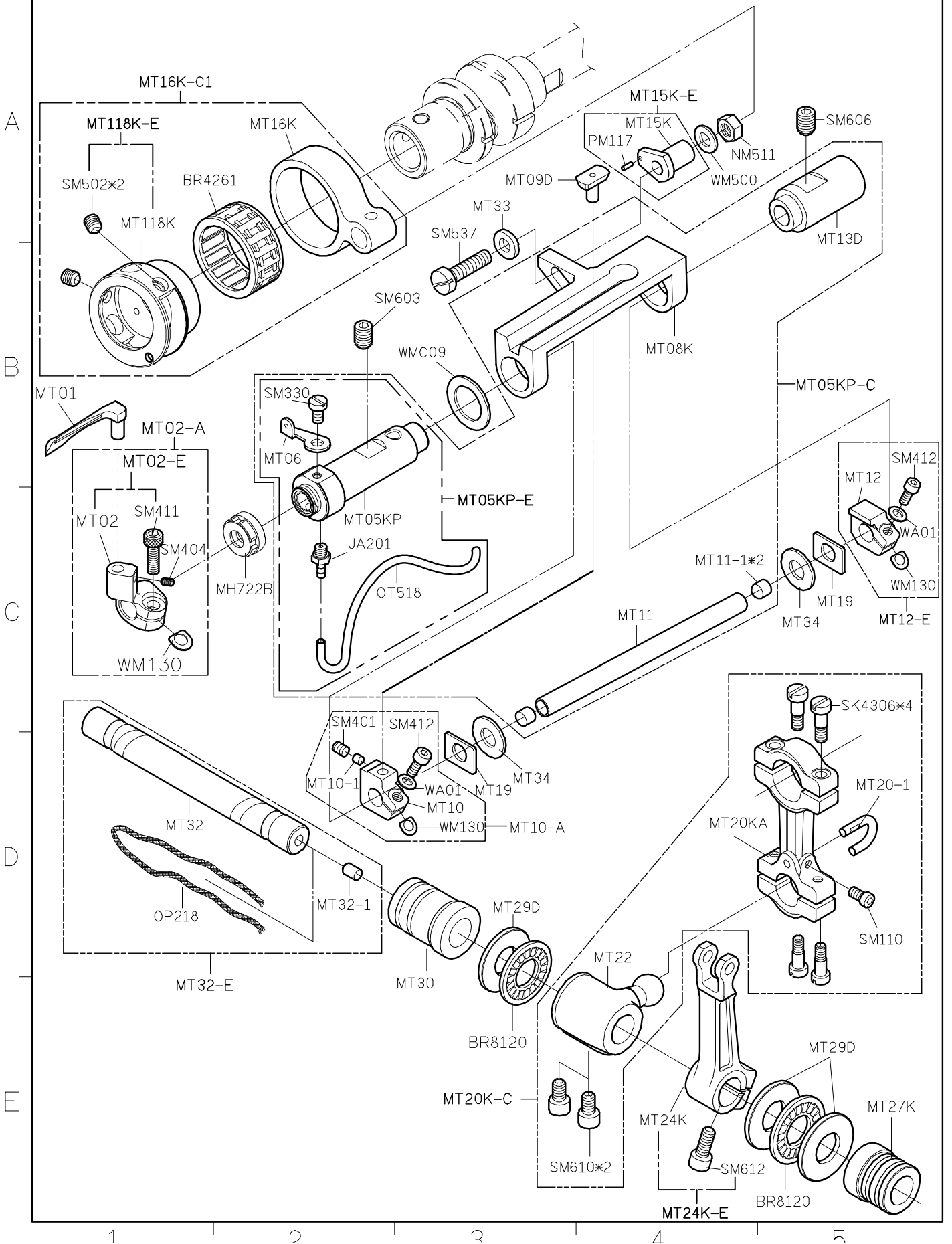

SIRUBA

PARTS LIST

Series

C007K/C007KD
C007KP/C858K

Parts Group

MU-K

Subclass / Remark

: Use for CR/CRL

Page

1/1

Date

2018/10/16

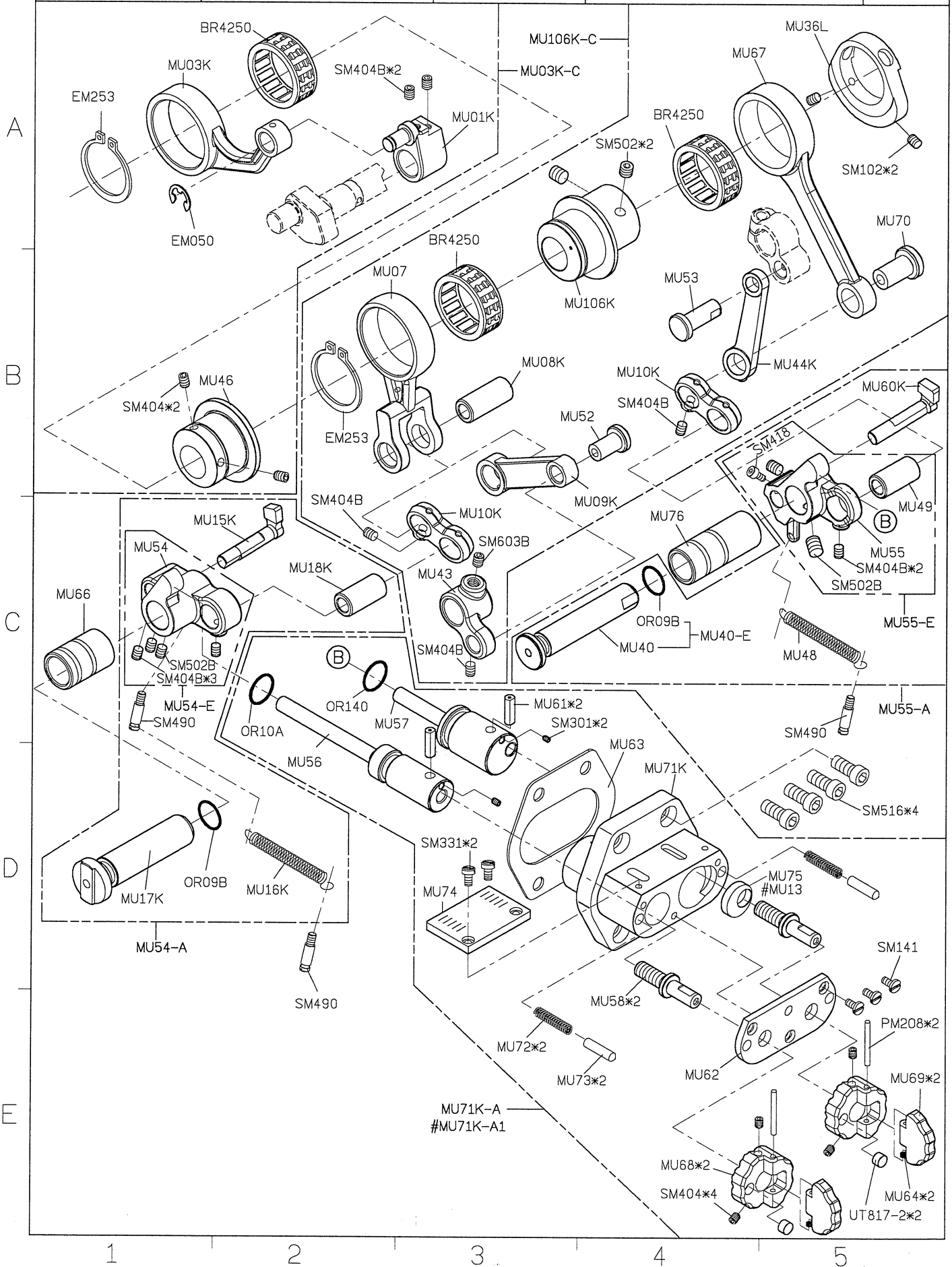

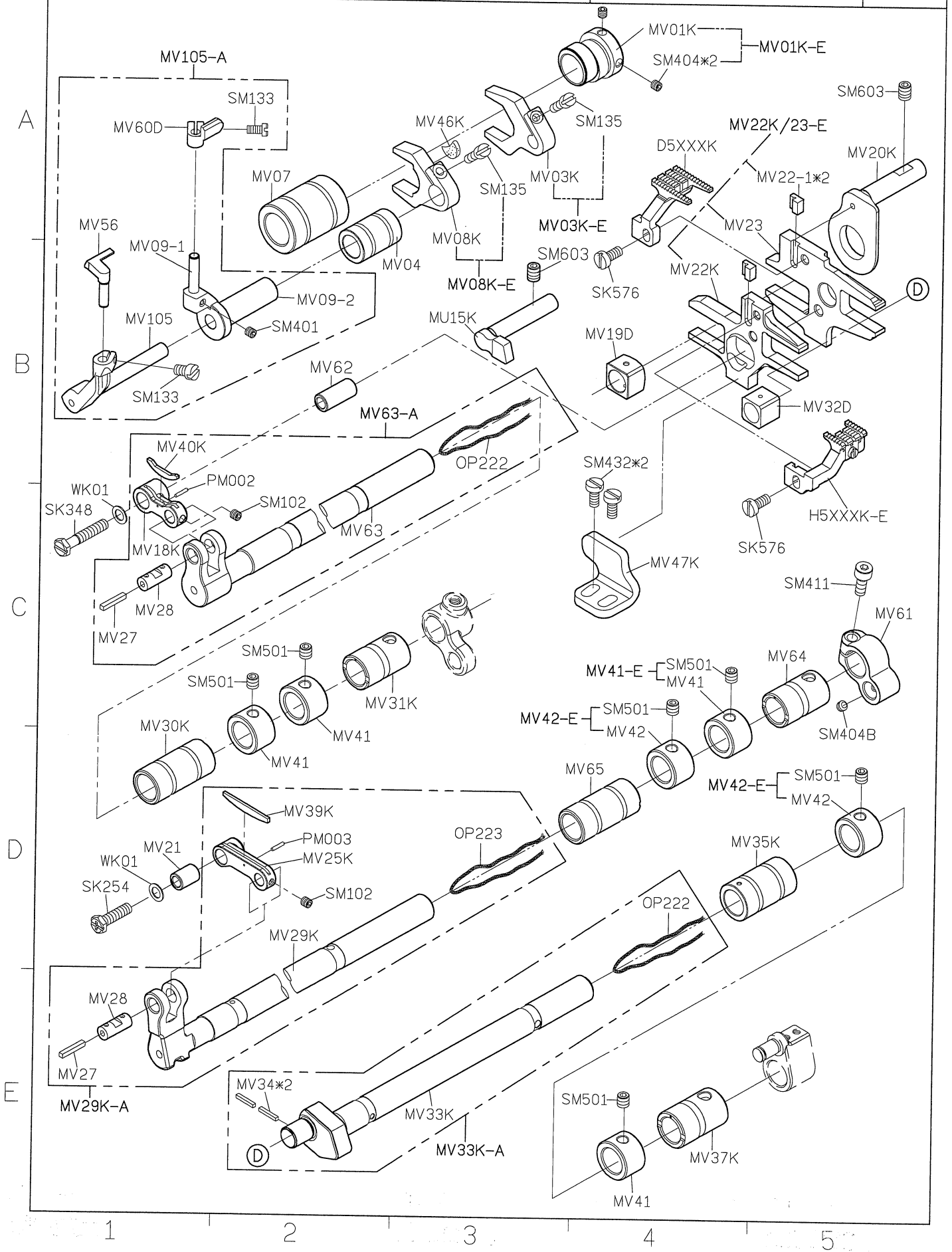

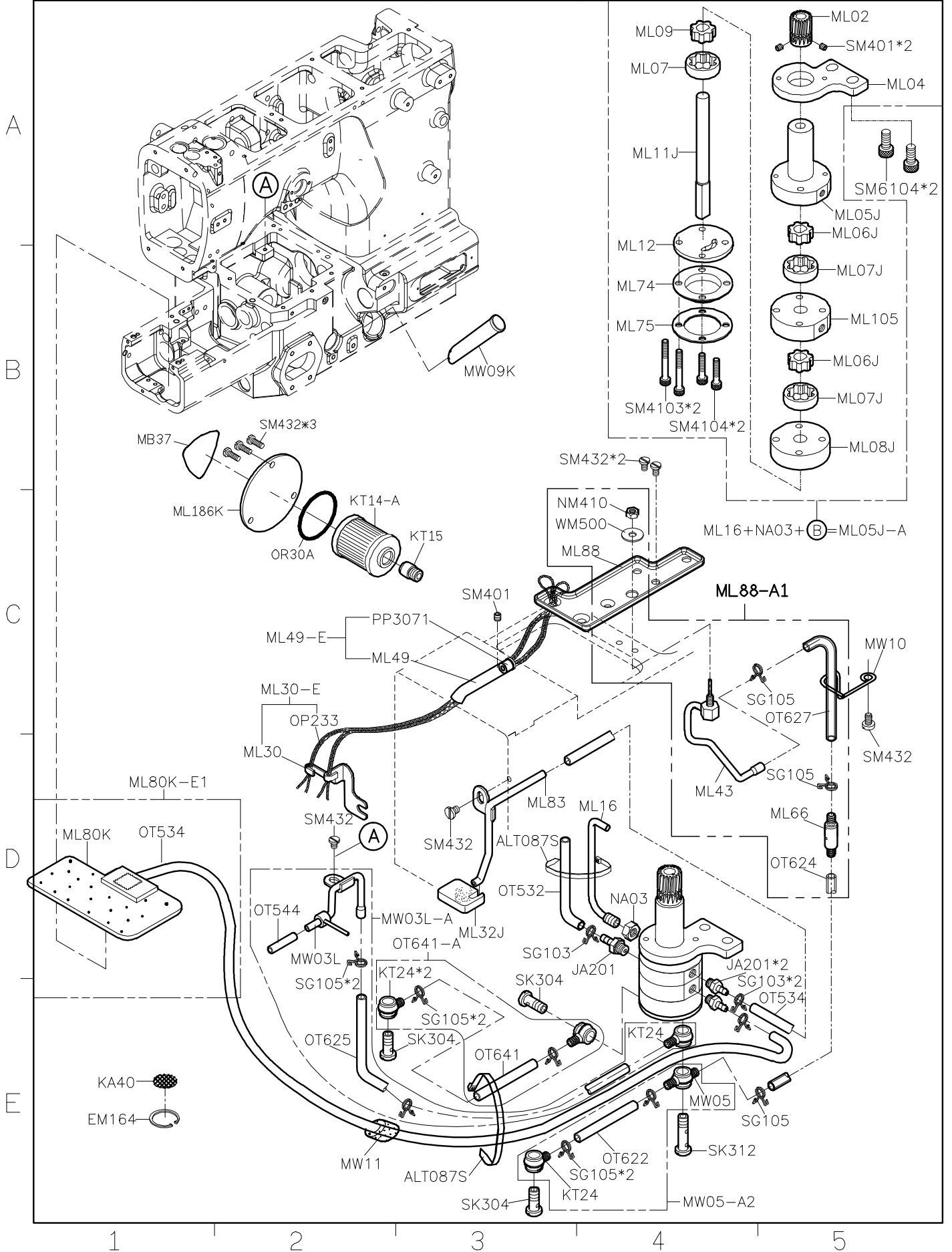

SIRUBA PARTS LIST	Series	Parts Group	Subclass / Remark	Page
	C007K/C007KD C007KP/C858K	MY-K		1/1
				Date
				2021/01/12

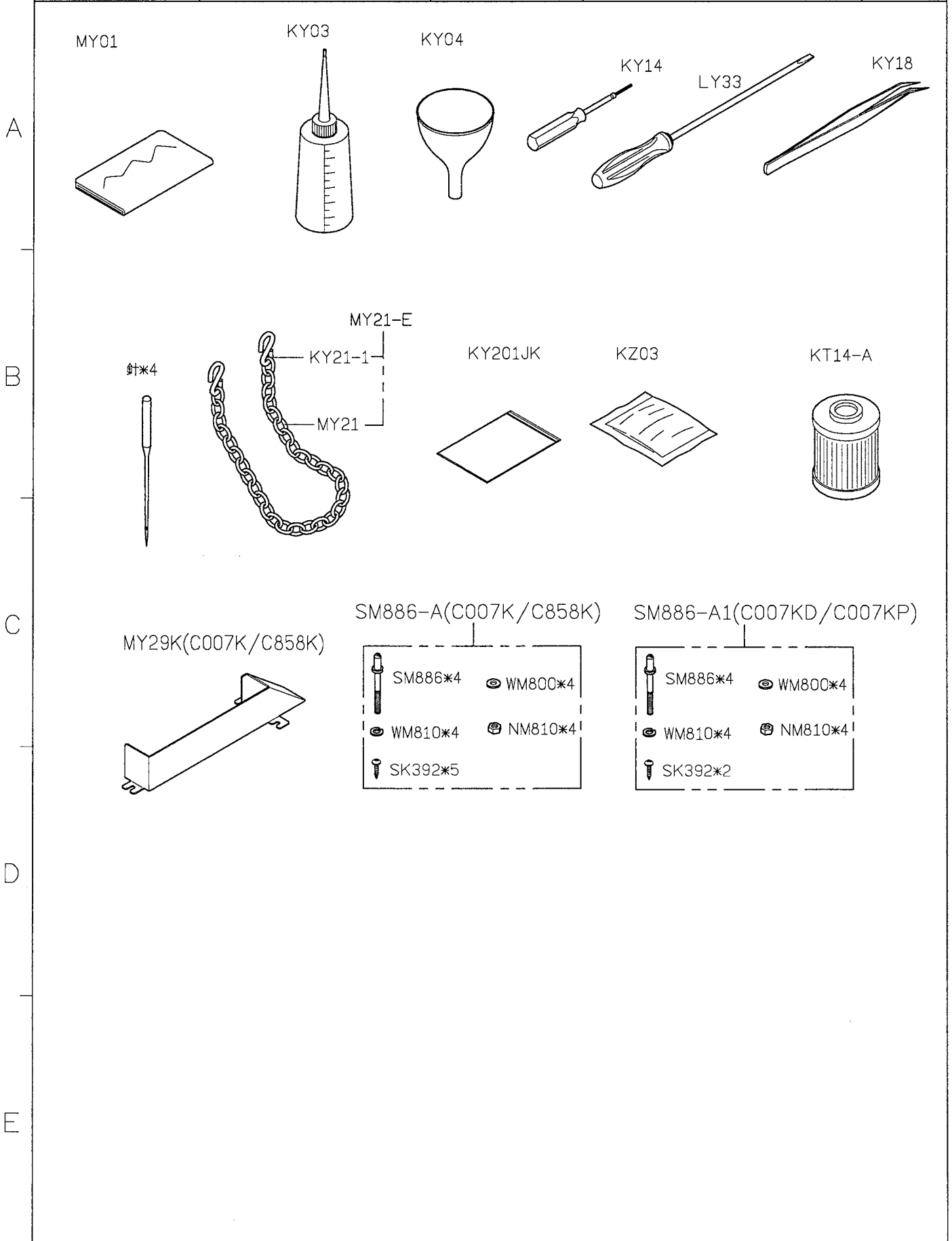

A

B

C

D

E

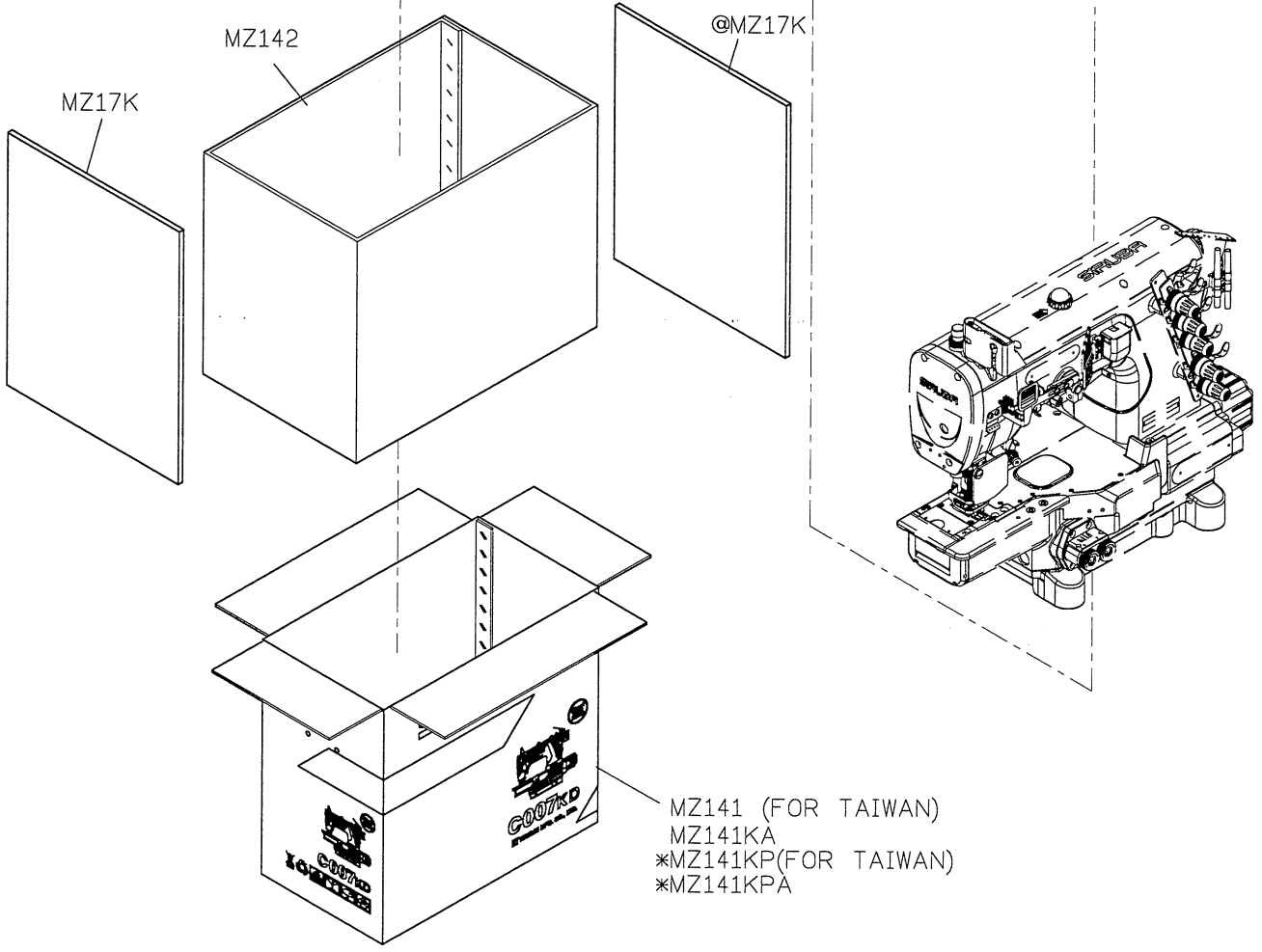
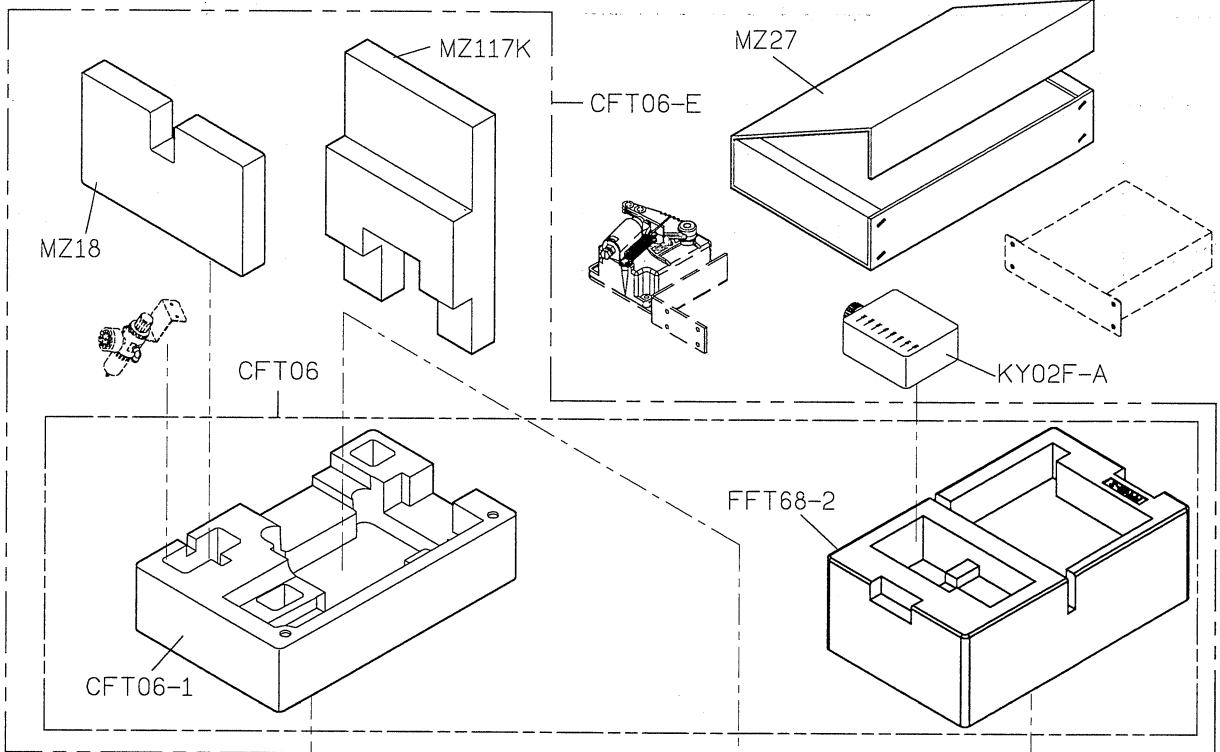

MZ141 (FOR TAIWAN)
MZ141KA
*MZ141KP(FOR TAIWAN)
*MZ141KPA

SIRUBA PARTS LIST	Series	Parts Group	Subclass / Remark	Page
	C007K/C007L	KW		1/1
	C007KP/F007K			Date
	S007K/U007			2020/8/18

KW01E-A

A

B

C

D

E

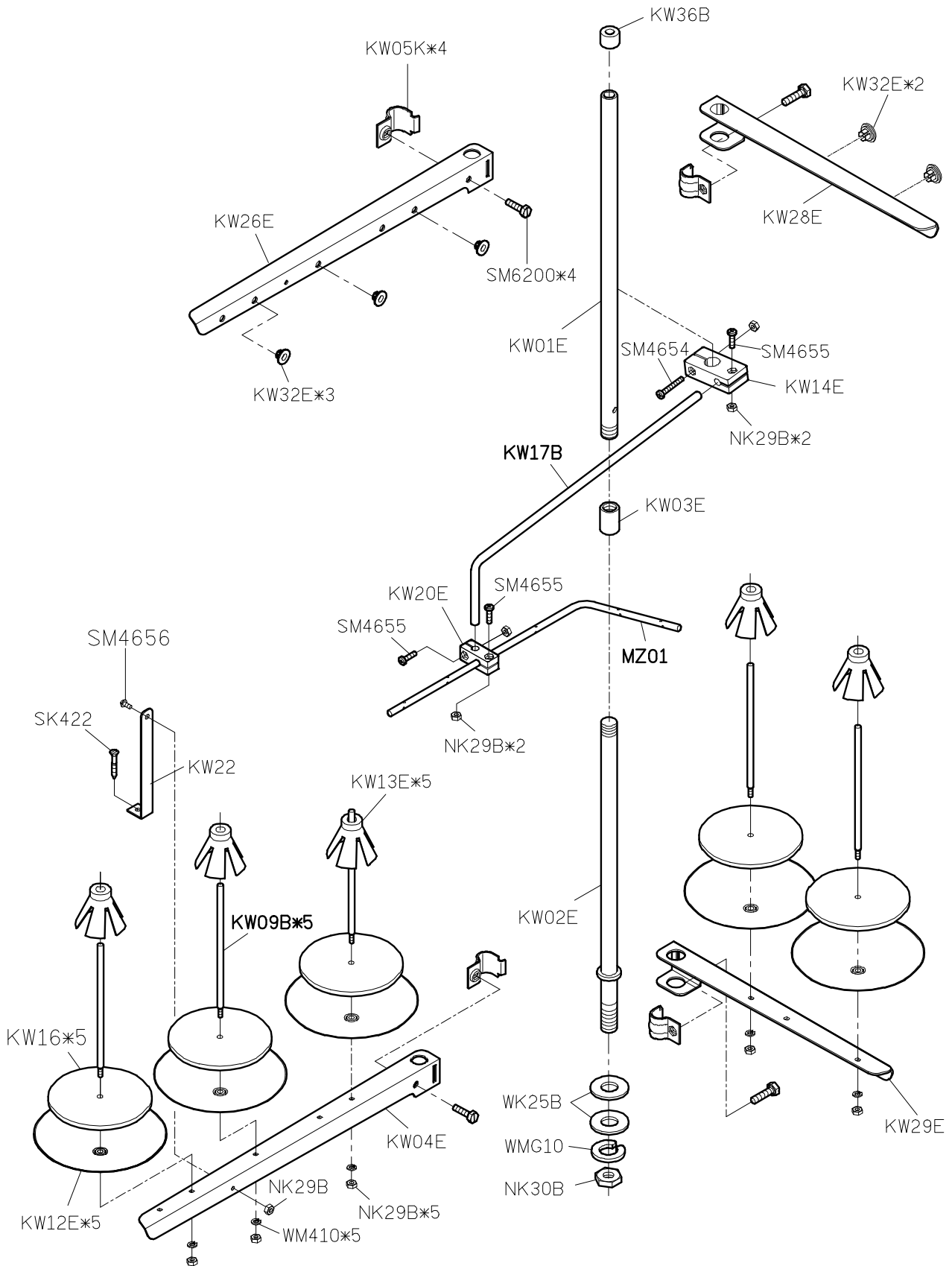

1

2

3

4

5

SIRUBATABLE
CUT - OUTSeries
C007K/C007KD
C007KP/C007JP
S007K/S007KD
U007Item Code
C007K-T23

Subclass / Remark

Mounting

Semi-submerged

Date

2023/10/20

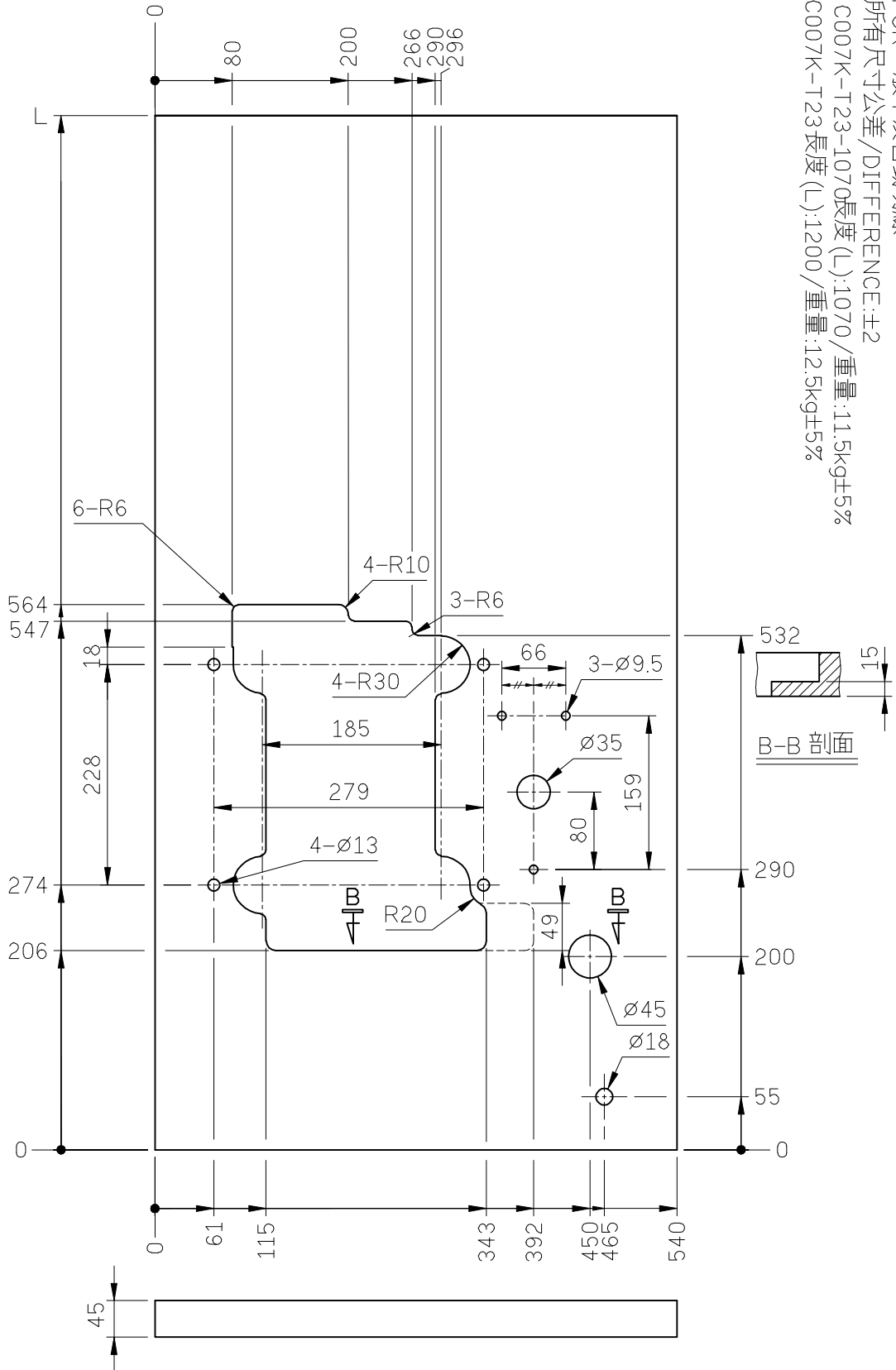

SIRUBATABLE
CUT - OUTSeries
C007K/C007KD
C007KP/C007JP
S007K/S007KD
U007Item Code
C007K-T25

Subclass / Remark

Mounting

Non-submerged

Date

2023/10/20

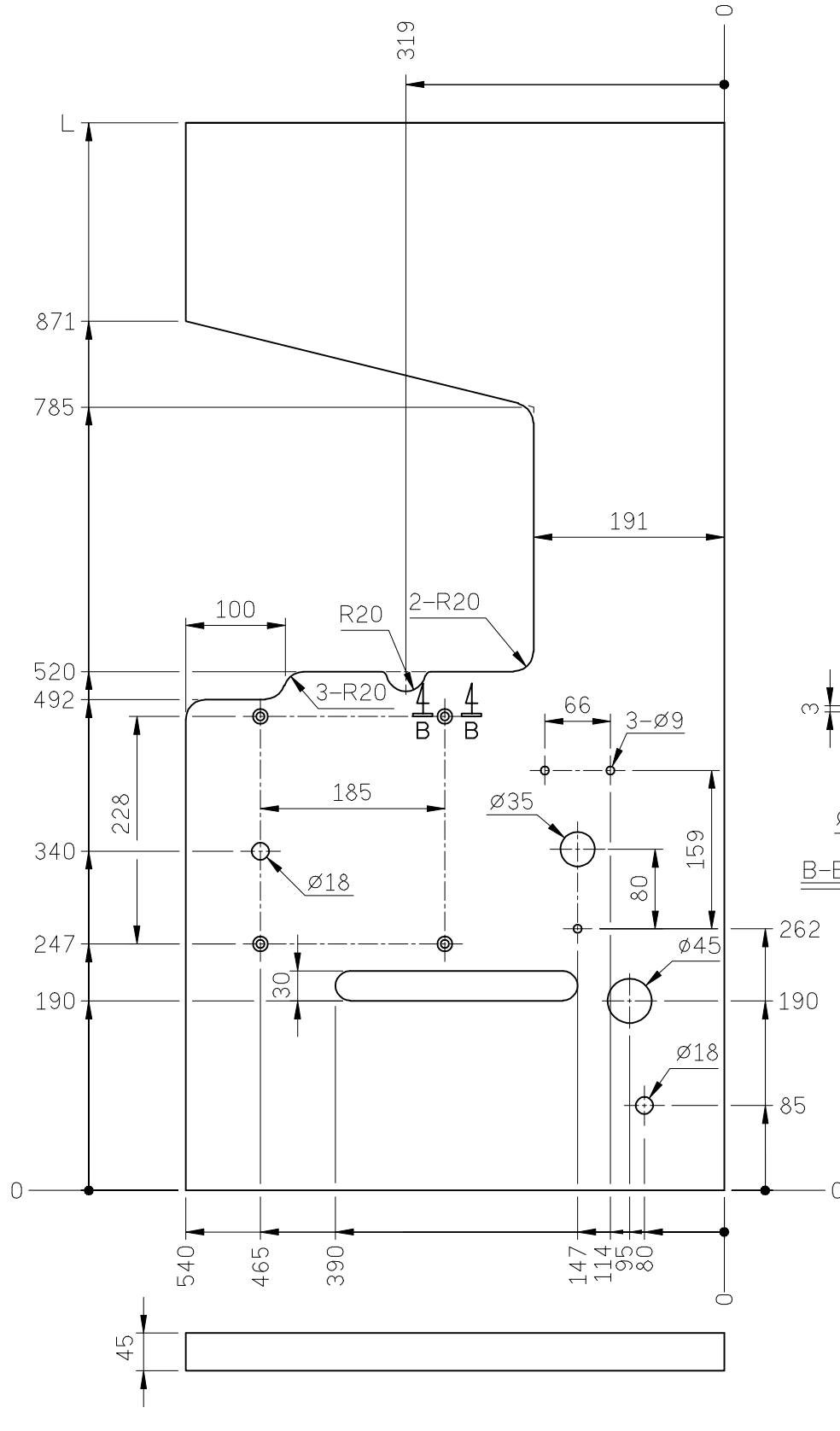

三針筒車上乘桌板圖
C007K/C007KD/C858K/C858KD SERIES TABLE CUT-OUT NON-SUBMERGED
單位/UNIT:mm
FOR C.R.L./UTP.Q
所有尺寸公差/DIFFERENCE:±2
C007K-T25-1070長度(L):1070/重量:11.3kg±5%
C007K-T25長度(L):1200/重量:12.3kg±5%

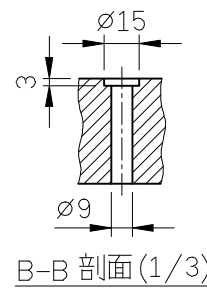

- □ MY29K-E (直埋式不用)
- MY29K
- SK391*3
- □ SM886-A1
- SM886*4
- WM800*4
- WM810*4
- NM810*4
- SK391*2

SIRUBATABLE
CUT - OUT

Series

C007K/C858K

Item Code

C007K-T26

Subclass / Remark

For CFC

Mounting

Semi-submerged

Date

2023/10/23

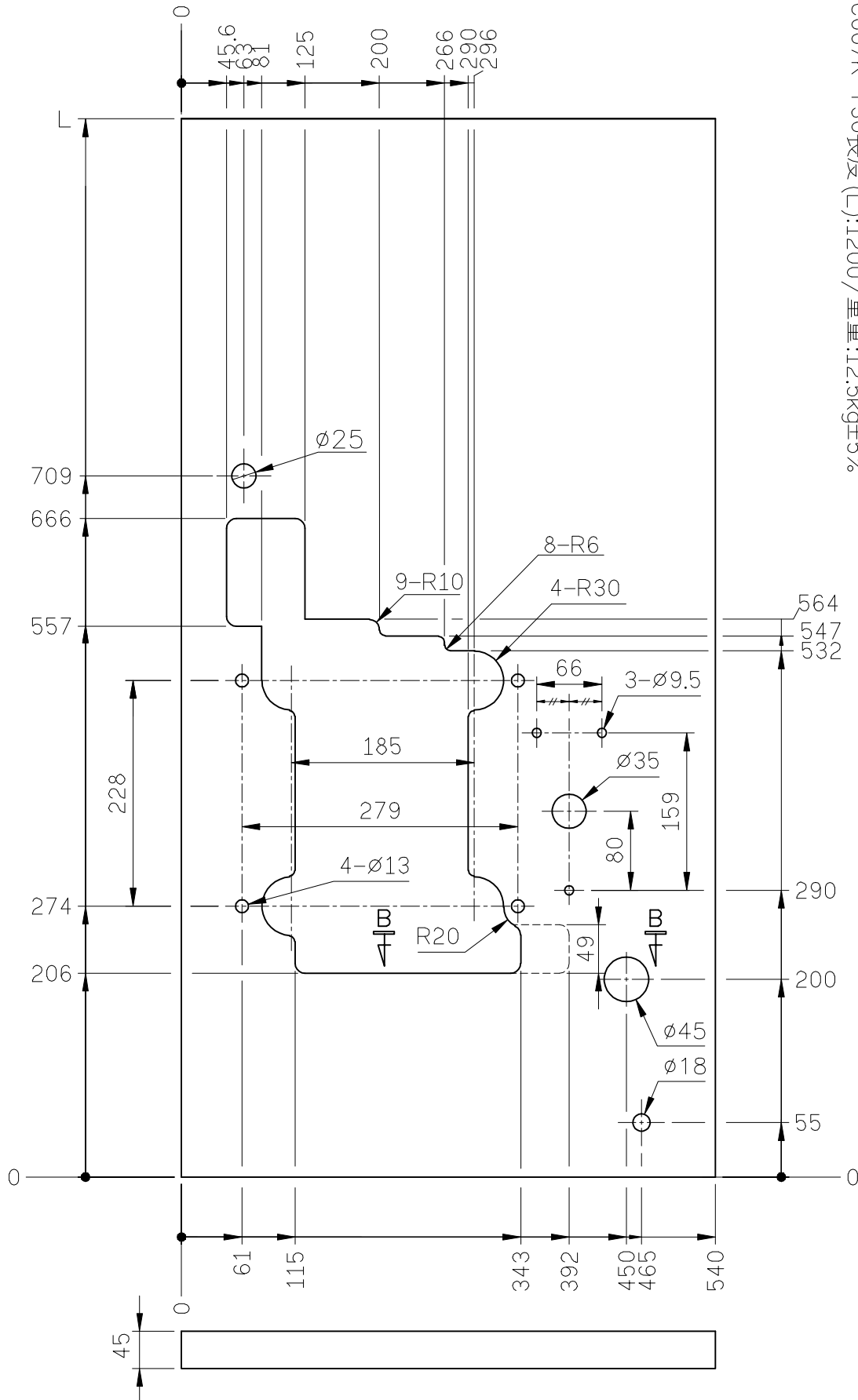

三針筒半乘桌板圖
 C007K/C858K SERIES TABLE CUT-OUT SEMI-SUBMERGED
 單位/UNIT:mm
 FOR CFC
 所有尺寸公差/DIFFERENCE:±2
 C007K-T26-1070長度(L):1070/重量:11.5kg±5%
 C007K-T30長度(L):1200/重量:12.5kg±5%

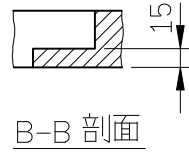

SIRUBATABLE
CUT - OUT

Series

C007K/S007K

Item Code

C007K-T32

Subclass / Remark

F0r all belt type series
machines

Mounting

Non-submerged

Date

2023/10/23

三針筒車上乘式桌板
 C007K/S007K SERIES TABLE CUT-OUT NON-SUBMERGED
 單位/UNIT:MM
 FOR一般車及自動切線
 所有尺寸公差/DIFFERENCE:±2
 for SILMAQ.

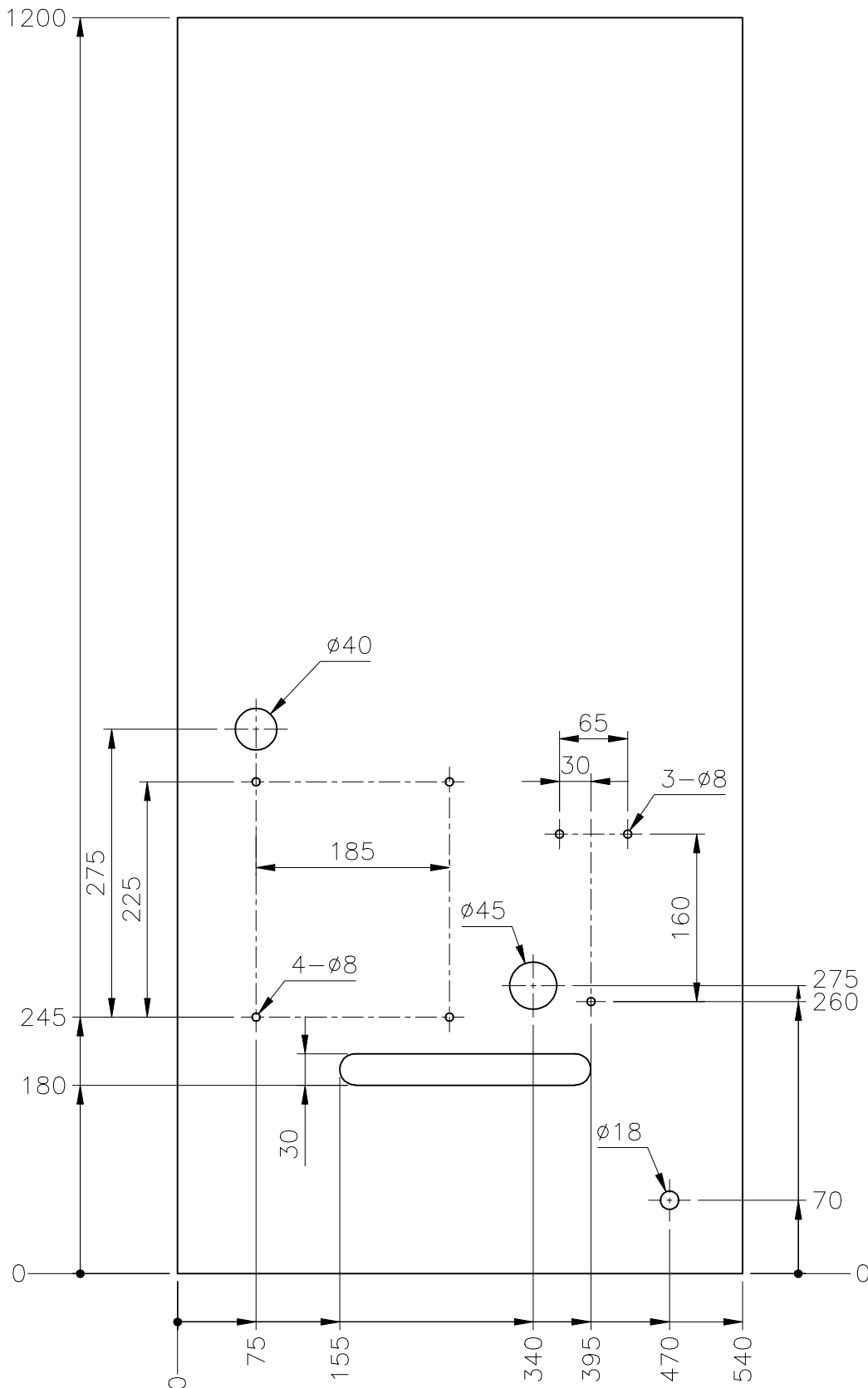

SIRUBATABLE
CUT - OUT

Series

C007KD/S007KD

Item Code

C007K-T33

Subclass / Remark

For all electronic direct drive
series machines

Mounting

Non-submerged

Date

2023/10/23

三針筒車上乘式桌板
C007KD/S007KD SERIES TABLE CUT-OUT NON-SUBMERGED
單位/UNIT:MM
FOR一般車及自動切線
所有尺寸公差/DIFFERENCE:±2
for SILMAQ.

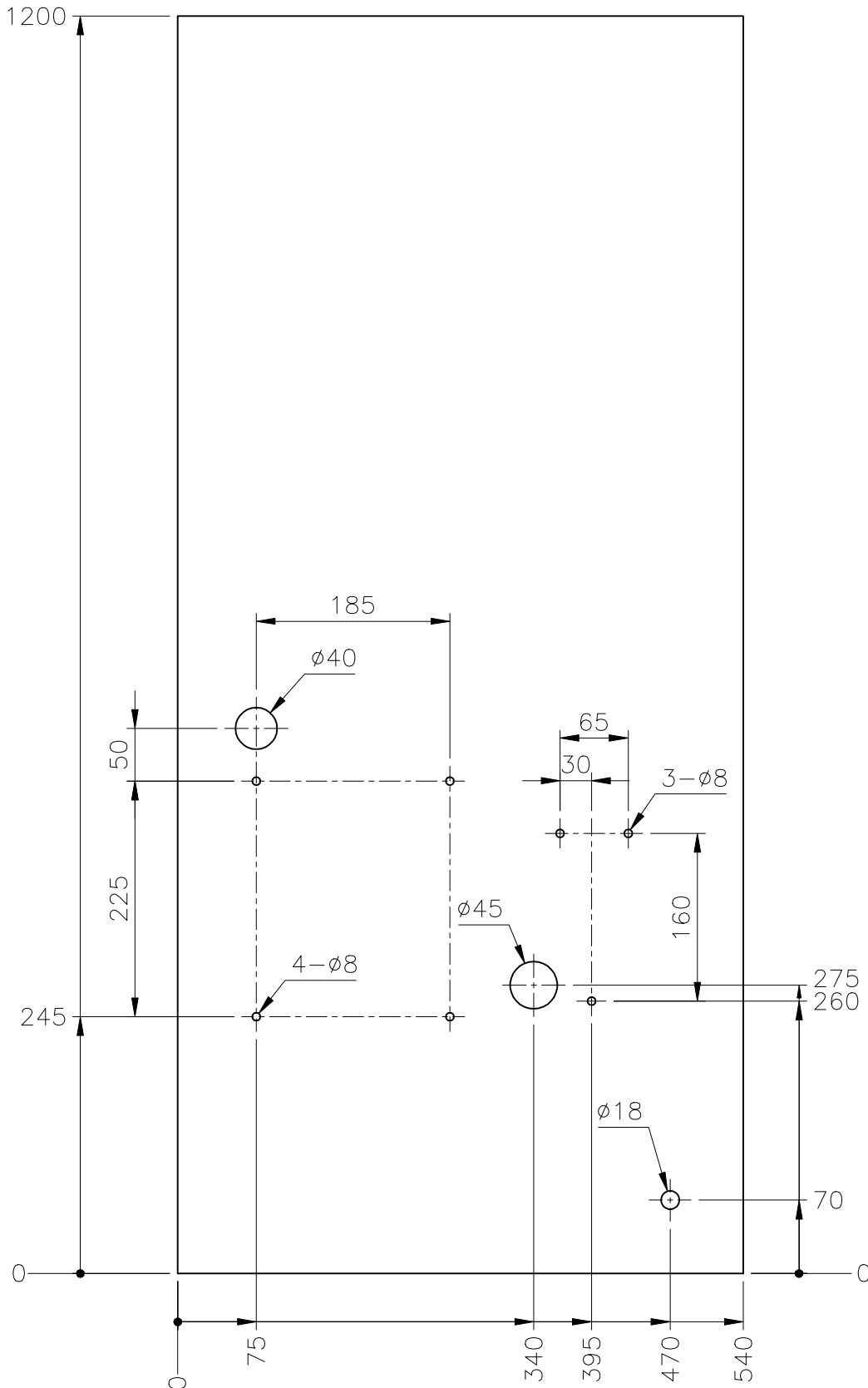

SIRUBA TABLE CUT - OUT	Series	Item Code	Subclass / Remark	Mounting
	C007KD/C007KP S007KD	C007KD-T23		Semi-submerged
				Date
				2023/6/21

